



**Sun™ 24.1-inch LCD Flat Panel Monitor**

**Sun™ Moniteur à écran plat LCD de 24,1 pouces**

**Sun™ 24,1 Zoll LCD Flachbildschirm**

**Monitor de Pantalla Plana LCD de 24,1 pulgadas de Sun™**

**Sun™ Monitor a schermo piatto LCD da 24,1 pollici**

**Översikt över 24,1-tums LCD-bildskärm**

**24,1-дюймовый цифровой монитор Sun™ с  
плоскопанельным ЖК-дисплеем**

**Sun™ 24.1 インチ LCD フラット パネル モニター**

**Sun™ 24.1 인치 LCD 평면 디스플레이**



**Sun™ 24.1 英寸 LCD 平板显示器**

**Sun™ 24.1 英吋 LCD 平板顯示器**

**Owner's  
Guide**

# Safety Instructions

1. Never use your monitor if the power cord has been damaged. Do not allow anything to rest on the power cord, and keep the cord away from areas where people can trip over it.
2. Be sure to hold the plug, not the cord, when disconnecting it from an electric socket.
3. Openings in the monitor cabinet are provided for ventilation. To prevent overheating, these openings should not be blocked or covered. Also, avoid using the monitor on a bed, sofa, rug, or other soft surface. Doing so may block the ventilation openings in the bottom of the cabinet. If you put the monitor in a bookcase or some other enclosed space, be sure to provide adequate ventilation.
4. Put your monitor in a location with low humidity and a minimum of dust.
5. Do not expose the monitor to rain or use it near water (in kitchens, near swimming pools, etc.). If the monitor accidentally gets wet, unplug it and contact an authorized dealer immediately. You can clean the monitor with a lightly dampened cloth when necessary, but be sure to unplug the monitor first.
6. Place the monitor on a solid surface and treat it carefully. The screen is made of thin glass with a plastic front surface and can be damaged if dropped, hit, or scratched.
7. If your monitor does not operate normally – in particular, if there are any unusual sounds or smells coming from it – unplug it immediately and contact an authorized dealer or service center.
8. High temperatures can cause problems. Don't use your monitor in direct sunlight, and keep it away from heaters, stoves, fireplaces, and other sources of heat.
9. Unplug your monitor from the AC outlet before any service.
10. Avoid all contact with a broken or damaged LCD panel assembly.

	<b>CAUTION</b> <b>RISK OF ELECTRIC SHOCK</b> <b>DO NOT OPEN</b>	
<b>CAUTION: TO REDUCE THE RISK OF ELECTRIC SHOCK, DO NOT REMOVE COVER (OR BACK). NO USER-SERVICEABLE PARTS INSIDE. REFER SERVICING TO QUALIFIED SERVICE PERSONNEL.</b>		

## **Maintenance of Your 24.1-inch LCD Monitor**

**WARNING: To avoid risk of electric shock, do not disassemble the monitor cabinet. The unit is not user-serviceable. User maintenance is restricted to cleaning as explained below:**

Unplug the monitor power supply from the power outlet before cleaning.

- To clean the screen, use a soft dry cloth or a soft cloth lightly dampened with water.
- To clean the monitor cabinet, use a cloth lightly dampened with a mild detergent.

*Never use harsh cleansers, solvents or flammable cleaning materials to clean your monitor.*

- The screen is delicate. Do not touch or strike the screen with any sharp object, such as a fingernail, pen, pointer, etc. Use caution when touching by hand.
- Never lay the monitor on panel face.
- Do not operate with display head tilted in excess of 30 degrees.
- Place the monitor only on a flat surface with both feet away from any edges to avoid toppling.
- Cable connections should be made from the front. Tilt the panel head back at the top.

*Do not access the unit from the rear by rotating the unit or laying it on the display face.*

*For optimal performance, use only the supplied Sun™ Microsystems video cables that are included with your 24.1-inch LCD Monitor.*

# Preface

The *Sun™ 24.1-inch LCD Monitor Owner's Guide* contains important information about the set up and use of your new monitor.

- Provides setup and installation instructions.
- Provides use and care information.
- Describes controls and features.
- Suggests troubleshooting steps you can take to resolve issues on your own.
- Details monitor specifications.

# Package Contents

- 24.1-inch LCD Monitor, with stand
- Power supply
- Cable kit with:
  - 1 - DVD-D to DVI-D (digital video) (*DVI-I and DVI-A cables are not compatible with this monitor.*)
  - 1 - 13W3 to 13W3 (analog video)
  - 1 - 13W3 to HD15 (analog video)

*For optimal performance, use only the supplied Sun™ Microsystems video cables that are included with your 24.1-inch LCD Monitor.*

- 1 - C-Video (composite)
- 1 - S-Video
- 1 - USB (upstream)
- Setup poster
- Screen protector sheet
- CD with:
  - Owner's Guide
  - Video image test file(s)

## ***Where to Find Additional Information***

- Check the included CD (705-0087-10) for additional content. Note that some co-packaged products contain materials on their respective CDs.
- The *docs.sun.com* website enables you to access Sun technical documentation on the Web. You can browse the *docs.sun.com* archive or search for a specific book title or subject at:
  - <http://docs.sun.com>

## Overview of Your

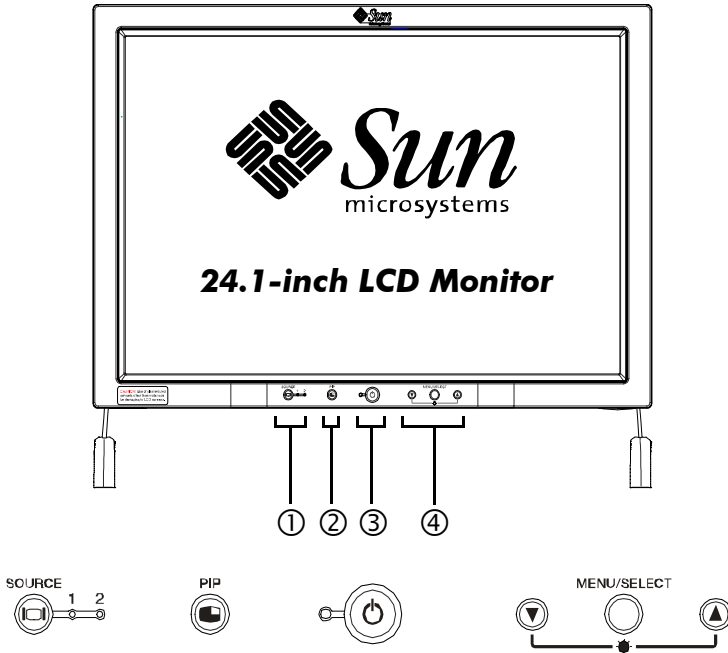

**Figure 1-1. Front panel**

### 1. Video source selector (1 ~ 2) and indicator lights

Your Sun™ 24.1-inch LCD Monitor allows you to connect as many as four video sources (two computer and two auxiliary video) at one time. Use this button to select which source your monitor should display. Indicator “1” glows green when a computer workstation (digital or analog) is active and indicator “2” glows green when an external video source (C-VIDEO/S-VIDEO) is active.

*Notice the text at the top right of the screen, momentarily indicating which of the four inputs (or PIP combination) is selected.*

### 2. PIP

Use this button to activate the PIP (picture-in-picture) feature.

### 3. Power button and indicator light

Use this button to turn the monitor on and off. The power indicator light glows green during normal operation and amber if no signal is supplied.

### 4. On-Screen Menu adjustment controls and direct-access controls

Use these buttons to access the on-screen menu (OSM), the Brightness Direct-Access controls, and to make adjustments to the various OSM features. See “Accessing the On-Screen Menu System” on page 14.

## Connectors and features

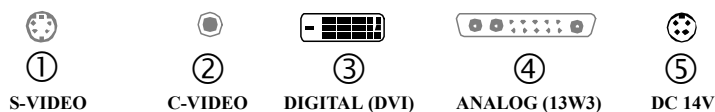

**Figure 1-2. Back panel connectors**

*Note: Connections should always be made from the front to avoid toppling the monitor. Never lay the monitor on its face.*

#### 1. S-Video connector

Connect a DVD player, etc. to this connector. When this source is active, ‘SOURCE’ indicator 2 glows green.

#### 2. C-Video (Composite) connector

Connect a VCR, digital camera, etc. to this connector. When this source is active, ‘SOURCE’ indicator 2 glows green.

*Note: All NTSC, PAL and SECAM video input signal formats are compatible with both C-Video and S-Video.*

#### 3. ANALOG (13W3) signal cable connector

Connect an analog video input cable\* to this connector. When the workstation (computer sourced) is active, ‘SOURCE’ indicator 1 glows green.

#### 4. DIGITAL (DVI) signal cable connector

Connect a DVI-D cable\* from the video connector on your workstation to this connector. When the workstation is active, ‘SOURCE’ indicator 1 glows green. (DVI-I and DVI-A connectors/cables are not compatible.)

\* DVI-D-to-DVI-D (*digital, 3 meter*) video cable is included with this monitor, along with a 13W3-to-13W3 (*analog, 2 meter*) and 13W3-to-HD15-pin (*analog, 1.8 meter*) video cable.

**5. DC14V power adapter connector**

Connect the power adapter jack here. (*power cord for adapter to wall outlet is supplied in the computer system country kit*)

**6. USB hub/ports**

For your convenience, a powered USB hub is built into the monitor. This built-in USB hub includes one upstream and four downstream USB ports. Connect the upstream port to your workstation or another hub. Connect USB devices (mouse, keyboard, etc.) to the four (downstream) ports.

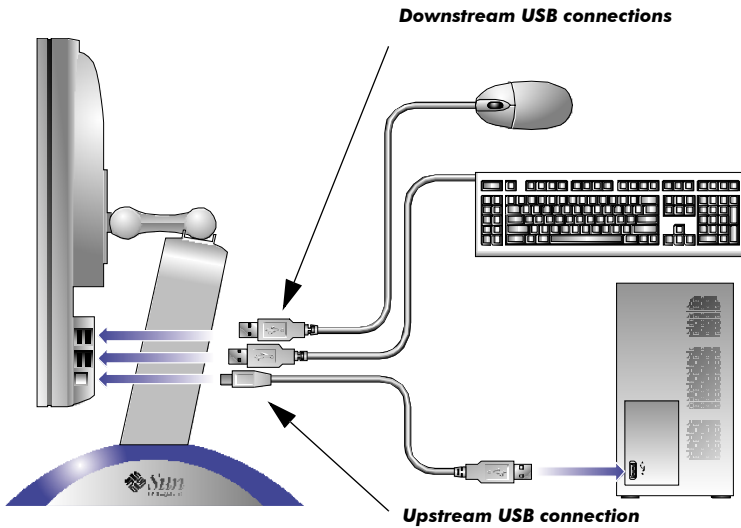
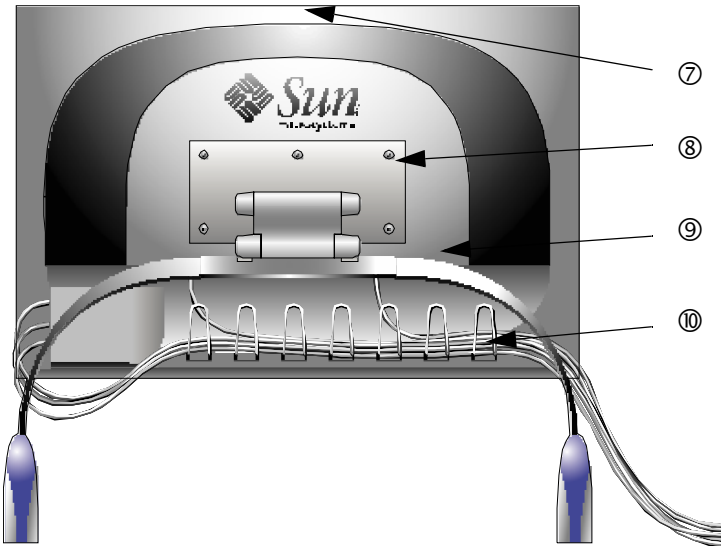

**Figure 1-3. USB connections**



## 7. Camera Mounting Pad

A retractable camera mounting pad (top center) is provided for convenient placement of a digital camera such as the Sun Microsystems 1394 Firewire camera, P/N 370-4161-01. (*Note: 1394 cameras will not plug into this monitor.*)



**Figure 1-4. Rear view**

## 8. Universal Mechanical Mount

The unique adjustable pivoting mechanism allows for independent adjustment of height and tilt.

## 9. Kensington security slot

This monitor offers you the opportunity to attach a Kensington-type security device to the back of the monitor. *Kensington lock not included.* Refer to your locking device documentation for installation instructions.

## 10. Cable Management Clips

Use the seven stainless steel clips on the back of the monitor to organize and manage your cables.

# Installation

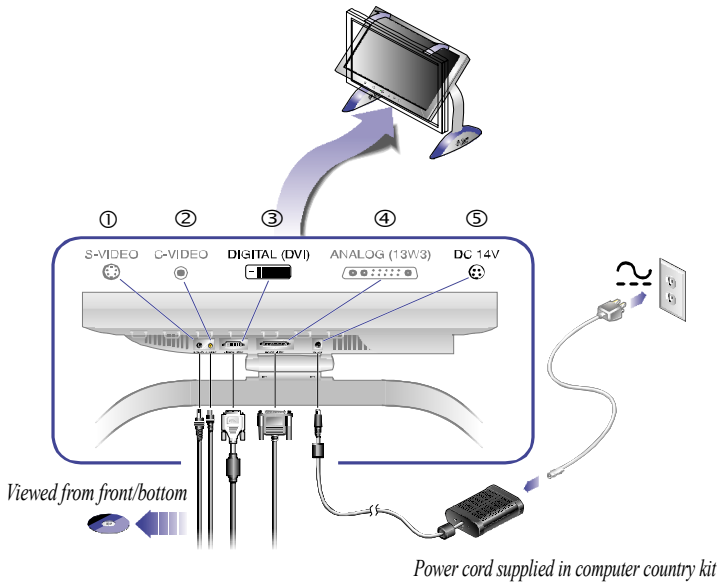

**Figure 1-5. Connecting your monitor to a computer**

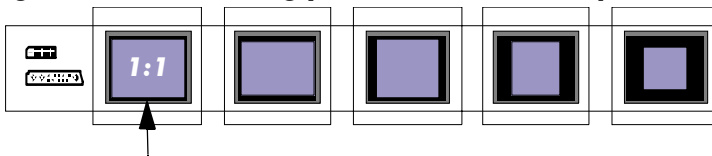

*Note: 1920 X 1200 is the native, primary, and default (1:1) resolution of this monitor.*

*Use of resolutions below 1920 X 1200 will result in:*

- 1.) distorted image if expanded.*
- 2.) unused area surrounding the image. See "Image Size" on page 18.*

**1. Tilt the monitor up so that you can access the cable connectors along the bottom/rear of the unit.**

*Note: Always connect cables from the front of the unit to avoid toppling the monitor. Never lay the monitor on its face.*

**2. When connecting your monitor to a digital workstation, connect the signal cable to the DIGITAL (DVI) connector (③). Connect the other end of the cable to the digital video port on the back of your workstation.**

When connecting your monitor to an analog computer:

- Connect either the 13W3-to-13W3 cable or the 13W3-to-HD15 cable (both supplied with monitor) to the ANALOG (13W3) connector (④).
- Connect the other end of the cable to the analog video port on the back of your computer. *Use the cable that matches your system.*

*Note: One or both types of signal cables can be connected to the monitor simultaneously.*

There are three types of computer cables included with your monitor:

- DVD-D to DVI-D (digital) (*DVI-I and DVI-A cables are not compatible with this monitor.*)
- 13W3 to 13W3 (analog)
- 13W3 to HD15 (analog)

*For optimal performance, use only the supplied Sun™ Microsystems video cables that are included with your 24.1-inch LCD Monitor.*

In addition to the above, included are the following general purpose cables that can also be connected at this time:

- C-Video (composite)
- S-Video
- USB (upstream)

**3. Connect the DC 14V power adapter jack to the power port (⑤) on the back of the monitor. Connect the power cord (supplied in the computer system country kit) for the power adapter to a properly grounded outlet.**

*Note: The power supply is universal, and will operate worldwide.*

4. **Plug the power cords from your system and your monitor into a nearby outlet.**
5. **Turn on your system and monitor. If your monitor displays an image from the computer, installation is complete.**
6. **Optimize the picture as described in "Auto Adjustment" on page 8\*.**

*\*Auto adjustment is for 'ANALOG (13W3)' video only.*

**7. Adjust the height and tilt of the monitor.**

The stand/mount allows you to tilt the monitor for various viewing angles. It also includes a double-pivot feature that allows you to independently adjust the overall height of the monitor from 468 mm to 518 mm (nominal).

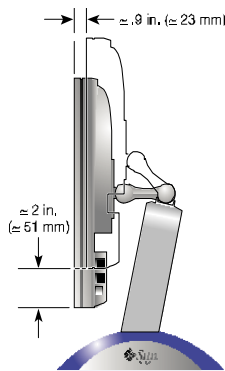

**Figure 1-6. Monitor side view**

**8. When mounting a digital camera, such as the Sun Microsystems 1394 Firewire camera P/N 370-4161-01, please note the following:**

- Use of double-sided tape, etc. is recommended for stable attachment to the camera pad.
- Make sure the retractable pad is free from adhesive before closing.

*Note: 1394 camera connection not supported by this monitor.*

## Getting Help

If your monitor does not display an image, check your cable connections and refer to “Troubleshooting” on page 24. If you experience difficulties with the quality of the displayed image, run ‘Auto adjustment’\* again and refer to “Adjusting Your Monitor” on page 11.

*\*Auto Adjustment is for ‘ANALOG (13W3)’ video only.*

## Hot Plug Capability

All monitor connections are ‘Hot Pluggable’, meaning they can be connected or disconnected at any time.

*Note: When making computer video cable/source changes, a system restart may be needed to update the computer’s awareness of the full resolution required by the monitor. 1920 X 1200 is recommended as the primary resolution setting.*

## Plug and Play

Our adoption of the VESA<sup>®</sup> Plug and Play solution eliminates complicated and time consuming setup. It allows you to install your monitor in a Plug and Play compatible system without the usual hassles and confusion. Your system can easily identify and configure itself for use with your display. This monitor automatically tells the system its Extended Display Identification Data (EDID) using Display Data Channel (DDC) protocols so the system can automatically configure itself to use the monitor.

## Auto Adjustment - ANALOG (13W3) only

Even though your computer can recognize your new monitor, the auto adjustment feature can optimize the display settings for your system.

- 1. Turn on your computer and monitor.**
- 2. Push the MENU/SELECT button to open the OSM.**
- 3. Push the down (▼) arrow button to activate the ‘Image Quality’ menu. Figure 1-7, page 9.**

4. Push the MENU/SELECT button to toggle into the 'Image Quality' sub-menu.
5. Use the down (▼) arrow button to select the 'Auto Adjustment' sub-menu.
6. Press MENU/SELECT to activate the 'No/Yes' sub-menu.
7. Use the down (▼) arrow button to select 'Yes'.
8. Press the MENU/SELECT button once to activate the Auto Adjustment feature. The screen dims and you may notice small changes to the screen image.

*Note: This and many other typical adjustments are not required (disabled) when using 'Digital (DVI)'. The precise nature of a digital signal minimizes the need for adjustment.*

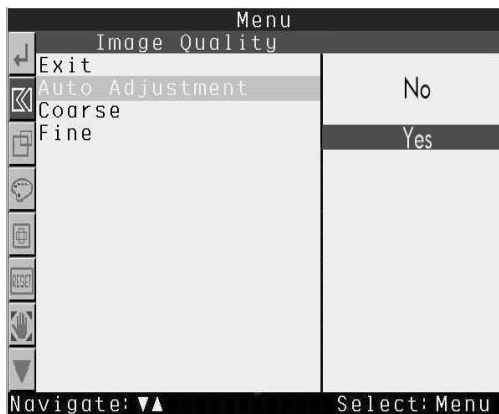

**Figure 1-7. Auto Adjustment sub-menu.**

9. When finished, the screen stops changing and returns to the OSM. Select 'EXIT' (push the up ▲ arrow button) and then MENU/SELECT and 'EXIT' once again to leave the OSM, or allow the OSM to time-out and disappear automatically.

*Note: 'Auto Adjustment' can be repeated for changes in video content, such as all text or full screen graphics.*

## Monitor Self Test - Analog and Digital

Your monitor provides a self test feature which allows you to check if your unit is functioning properly. If your monitor and computer are properly connected, but the monitor screen remains dark and the power indicator is blinking, use the following steps to perform the monitor self test.

- 1. Turn off both your workstation and the monitor.**
- 2. Unplug the video cable(s) from the computer or video card.**
- 3. Turn on the monitor.**

If the monitor is functioning properly, you should see a floating, white Sun Microsystems logo with text below it stating “Check Signal Cable”.



Check Signal Cable



**Figure 1-8. Monitor self test screen**

The three boxes are normally red, green, and blue. Failure of any of the boxes to appear correctly indicates a problem with your monitor. The logo and this alert also appear during normal operation of your monitor if the (computer) video cable becomes disconnected or damaged. The logo itself appears during power up.

*Note: This self test is only for computer video (Source 1 - Analog or Digital).*

**4. Turn off your monitor and reconnect the video cable; then turn on both your system and monitor.**

If your monitor screen remains blank after using the above procedure, check your video controller and computer system. A blank screen at this step indicates your monitor is functioning properly.

## Adjusting Your Monitor

Your monitor allows you to easily adjust the characteristics of the image being displayed. All adjustments are made using the control buttons on the front of the monitor.

While you use these buttons to adjust the controls, an on-screen menu (OSM) shows their numeric values and/or settings as they change.

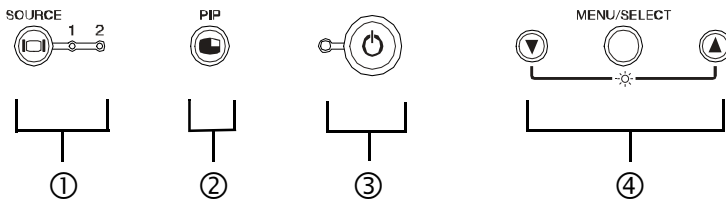

**Figure 1-9. User controls**

### 1. Source selector (1 ~ 2) button and indicators

The Source selector button allows you to choose between two different computer systems and two different video sources, all of which may be connected to your monitor at one time. “1” is for use with a workstation (digital or analog video signal), while “2” is for use with an external video source (C-Video/S-Video), such as a VCR, DVD player, or analog video camera signal. An indicator light glows green beneath the “1” or “2” characters, indicating which main source is active on the monitor screen.

*Notice the text at the top right of the screen, momentarily indicating which of the four inputs (or PIP combination) is selected.*



## 2. PIP

The PIP button activates the “picture-in-picture” feature. You can relocate, resize, and deactivate the secondary window using the PIP Menu (OSM). Your monitor also includes PBP (picture-by-picture), which allows you to split the screen vertically into two zones (left and right). Use the OSM to select and configure these features.

Pressing the PIP button a second time toggles the external video source (C-Video/S-Video - NTSC, PAL, and SECAM, etc.) to full screen, while pressing it a third time results in the computer video as PIP. Notice the text at the top right of the screen, momentarily indicating which of the four inputs (or PIP combination) is selected.

*Note: The default sequence and operation of these features varies depending on the type and number of sources that are connected and enabled.*

## 3. Power button and indicator

Use this button to turn the monitor on or off. The power indicator light glows green during normal operation and amber when the monitor is in sleep mode. Notice the white Sun Microsystems logo that appears during routine power on and when entering sleep mode.

## 4. MENU/SELECT button

This button opens the OSM system and activates the highlighted function. If the OSM is allowed to time out (versus exiting) it remembers the last menu in use. Selected menus highlight blue to indicate available and related choices.

## 5. The (▼/▲ and ☉/☽) buttons

When used with the OSM, these buttons allow you to select sub-menu items and to move the selector between menus on the OSM. When adjusting an item using the OSM, the down (▼) button lowers the value of the selected function, and the up (▲) button raises the value of the selected function.

These buttons are also direct-access buttons for the Brightness feature control. See “Direct-Access Features” on page 13.

## Automatic Save

Whenever you open the on-screen display and allow an adjustment window to remain on-screen for approximately twenty seconds (default) without pressing another button, this monitor automatically saves any adjustments you have made.

If you have made no adjustments, the on-screen menu disappears and the monitor does not save anything.

## Direct-Access Features

The features described in this section can be accessed quickly, at the touch of a button.

### Brightness

Follow these instructions to adjust the brightness of the monitor's display.

1. **With the menu off, push the up (▲) or down (▼) button. The brightness display adjustment menu appears.**



**Figure 1-10. Direct-Access Brightness Menu**

2. **Pressing the up (▲) or down (▼) buttons raises or lowers the brightness accordingly. Press the MENU/SELECT button to exit the 'Brightness' menu. You can also wait for the menu to disappear automatically.**

### On-Screen Menu (OSM) Lock/Unlock

This feature allows you to secure current monitor settings (while allowing you to adjust Brightness), so that they cannot be inadvertently changed. You can unlock the OSM controls at any time by using the same procedure.

1. **Push and hold the MENU/SELECT button for 5 seconds to Lock or Unlock the controls. When locked, a “LOCKED” message is displayed in the bottom right of the menu window.**

## On-Screen Menu System

**Figure 1-11. On-Screen Menu (OSM)**



### Accessing the On-Screen Menu System

1. **With the menu off, push the MENU/SELECT button to open the OSM and display the main (Menu1) function menu.**

There are two pages of Menus that provide control over the features of your monitor; Menu1 and Menu2.

2. **Push the down (▼) button to move to the next icon or push the up (▲) button to move back to the previous icon.**

**As you move from one icon to another, the function name changes, and the selection is highlighted blue, to indicate the function(s) represented by that icon.**

See tables 1-1 (Menu1 Adjustments) and 1-2 (Menu2 Adjustments) to view a complete list of all the features\* and functions offered by this monitor.

*\*Note that some features are either active or disabled depending on the configuration of your various inputs and/or other features. A disabled feature is indicated by a dimmed icon. As an example, 'Image Size' is the only active icon on Menu1, when Source 1 DVI is active and selected.*

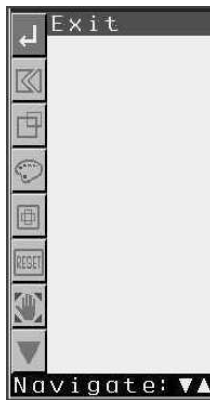

- 3. Push the down (▼) or up (▲) buttons to select an adjustment function, then push the MENU/SELECT button once to apply your changes.**
- 4. To return to the main menu, or to select another function, select the EXIT menu icon as required.**

**Figure 1-12. Exit Menu Icon**



- 5. To close or exit from the OSM, select the EXIT menu icon and then press the MENU/SELECT button.**

**Table 1-1. Menu1 Adjustments**

Icon	Settings and Sub-menus	Description
	<b>Image Quality</b> <ul style="list-style-type: none"><li>• Exit</li><li>• Fine</li><li>• Coarse</li></ul>	<p>ANALOG (13W3) only Exits this menu.</p> <p>Select this icon to compensate for variability from one video source to another, which can result in temporal instability.</p> <p>Use the down (▼) or up (▲) buttons to adjust away any instabilities.</p> <p>If satisfactory results are not obtained by using the Fine adjustment, first use the Coarse adjustment and then repeat with Fine adjustment.</p> <p>This function may change the width of the display image. Use the Horizontal function on the Position menu to center the display image on the screen.</p>
	<b>Position</b> <ul style="list-style-type: none"><li>• Exit</li><li>• Horizontal</li><li>• Vertical</li></ul>	<p>ANALOG (13W3) only Exits this menu.</p> <p>Select this icon to center or move the viewing area on the monitor screen.</p> <p>Use the down (▼) or up (▲) buttons to move the viewing area to the left or right when Horizontal is selected, and up and down when Vertical is selected.</p>



**Table 1-1. Menu Adjustments** (continued)

Icon	Settings and Sub-menus	Description
	<b>Level Adjust</b>	ANALOG (13W3) only See 'Reset' for additional information on handling these settings, and restoring defaults. Careful use of these adjustments, due to their effect on dynamic range (gamma) and color balance, is important to maintain optimal video quality. <i>Unnecessary use of this adjustment should be avoided.</i>
	• Exit	Select this icon to adjust the color hue and saturation. Exits this menu.
	• Preset	Individual color components are also user customizable. Use the down (▼) button to decrease the amount of the selected color. Use the up (▲) button to increase the amount of the selected color.
	• White • Red • Green • Blue	There are four 'color control' modes: <ul style="list-style-type: none"><li>• Reddish white</li><li>• Normal</li><li>• Bluish white</li><li>• User Customizable</li></ul>

**Table 1-1. Menu1 Adjustments** (continued)



Icon	Settings and Sub-menus	Description
	<b>Image Size</b>	<p>‘Aspect ratio’ is the proportion of vertical to horizontal resolution. This ratio varies, depending on the video resolution of each input (video signal/source). ‘Image Size’ control provides options for matching the screen size to your task.</p>
		<p>Your 24.1-inch LCD monitor has a native resolution of 1900x1200, which provides an aspect ratio of 16:10. If an image has an original aspect ratio of either 4:3 or 5:4, full screen display to 16:10 results in the image looking wider than it actually is. This type of image distortion is typically not appropriate for persons working in CAD, graphic design, etc. To resolve this issue, ‘Image Size’ control provides three image aspect ratio settings as outlined below.</p>
	<ul style="list-style-type: none"><li>• Exit</li></ul>	Exits this menu.
	<ul style="list-style-type: none"><li>• 16:10</li></ul>	Select 16:10 to extend the viewing area both horizontally and vertically to the full size of the monitor screen
	<ul style="list-style-type: none"><li>• 4:3</li></ul>	Select 4:3 to expand the viewing area to the full width of the monitor screen.
	<ul style="list-style-type: none"><li>• 1:1</li></ul>	Select the 1:1 setting to use the native size viewing area for the current signal. <i>(Recommended mode)</i>
	<b>Sharpness</b>	ANALOG (13W3) only
	<ul style="list-style-type: none"><li>• Sharpen</li><li>• Medium</li><li>• Soften</li></ul>	Use the down (▼) or up (▲) buttons to increase or decrease the sharpness of the screen image. <i>Sharpness is only effective for lower resolutions, and expanded mode (16:10/4:3).</i>

**Table 1-1. Menu1 Adjustments** (continued)



Icon	Settings and Sub-menus	Description
	<b>Reset</b> <ul style="list-style-type: none"><li>• Exit</li></ul>	ANALOG (13W3) only Exits this menu.  Select this icon to return to the factory-set values for the selected group of functions.
	<ul style="list-style-type: none"><li>• Geometry</li><li>• Color</li></ul>	Resetting 'Geometry' changes the Position settings, Image Quality settings, and changes the Image Size to 1:1.  Resetting the Color settings changes the colors back to their original factory settings.
	<b>Zoom/Pan</b>	This option allows you to magnify and shift the Workstation video image, to view various regions. <i>Disabled for native mode.</i>
	<ul style="list-style-type: none"><li>• Exit</li><li>• H-pan</li><li>• V-Pan</li></ul>	Exits this menu.  Use the down (▼) or up (▲) buttons to adjust.





**Table 1-2. Menu2 Adjustments**

Icon	Settings and Sub-menus	Description
	<b>PIP</b> <ul style="list-style-type: none"><li>• Exit</li><li>• On/Off</li> <li>• Size (in pixels) <i>400 X 300</i>  <i>640 X 480</i>  <i>800 X 600</i></li><li>• Horizontal Position</li><li>• Vertical Position</li></ul>	Picture-In-Picture  Exits this menu.  When active, this feature displays a secondary on-screen region that allows an additional video source to be viewed in a smaller window.  You can change the size and location of the window both horizontally and vertically.  <i>Note: This icon is dimmed (disabled) when PBP is active.</i>
	<b>PBP</b> <ul style="list-style-type: none"><li>• Exit</li><li>• On/Off</li> <li>• Mode <i>Video Right</i> <i>Video Left</i></li><li>• Workstation Source <i>Analog</i> <i>Digital</i><ul style="list-style-type: none"><li>• Video Source: <i>C-Video</i> <i>S-Video</i></li></ul></li></ul>	Picture-By-Picture  Exits this menu. Selecting this option enables/disables split-screen viewing, showing Workstation video (Source 1) side-by-side with any external video (Source 2).  You can switch the video sources from one side to the other as desired.  You can select from a total of four sources depending on your configuration (one pair for each side) Left: A or B; Right: C or D.  <i>Note: This icon is dimmed (disabled) when there is no C-Video source available and/or when PIP is active.</i>

**Table 1-2. Menu2 Adjustments** (continued)

Icon	Settings and Sub-menus	Description
	<b>Menu Options</b>	
	<b>Exit</b>	Exits this menu.
	Halfphone	Sets the transparency of the background of the OSM. Use the up and down arrow buttons to adjust.
	Menu Duration Time:	The OSM stays active for as long as it is in use. The Menu Display Time sets the length of time the OSM remains active after the last time you pushed a button. The default time is 20 seconds.
	<ul style="list-style-type: none"><li>• 5 sec</li><li>• 10 sec</li><li>• 20 sec</li><li>• 50 sec</li><li>• 200 sec</li></ul>	
	Language:	Select one of the five languages to use for the OSM.
	<ul style="list-style-type: none"><li>• English</li><li>• Deutsch</li><li>• Español</li><li>• Français</li><li>• Italiano</li></ul>	<i>The language chosen affects only the language of the OSM. It has no effect on any software running on the computer.</i>
	<b>Menu Position</b>	Sets the horizontal and vertical position of the OSM. Use the down (▼) or up (▲) buttons to adjust.
	<b>Exit</b>	Exits this menu.

**Table 1-2. Menu2 Adjustments** (continued)

Icon	Settings and Sub-menus	Description
	<b>Video Control</b>	C-VIDEO Source 2 only
	<b>Exit</b>	Exits this menu.  The color characteristics of composite video are often different from Workstation video. Use VIDEO CONTROL to adjust composite color, separate from Workstation video.
	<b>Brightness</b>	Increases or decreases the light intensity of composite video.
	<b>Contrast</b>	Increases or decreases the ratio of the light intensity between the brightest white and the darkest black.
	<b>Saturation</b>	Increases or decreases color depth.
	<b>Hue</b>	Changes color.  <i>Note this icon is dimmed (disabled) when there is no C-Video (Source 2) that is being used full screen.</i>
	<b>Monitor Information</b>	Select this icon to view the current user mode/settings, etc. This screen <i>only displays</i> information; you cannot select or modify any settings.  Information shown includes but not limited to: <ul style="list-style-type: none"><li>• (Workstation) Video Signal</li><li>• H-Sync</li><li>• V-Sync</li><li>• Pixel Clock</li><li>• Resolution</li></ul>

## PowerSaver

This monitor has a built-in power management system called PowerSaver. This system saves energy by switching your monitor into a low-power mode when it has not been used for a certain amount of time. The available modes are “On”, “Standby”, “Suspend”, and “Off”.

This system operates with a VESA DPMS compliant video card installed in your computer. You would use a software utility installed on your computer to set up this feature. See Table 1-3 below for details.

**Table 1-3. Power-saving modes**

State	Normal Operation	Power-Saving Function mode (EPA/NUTEK)		
		Standby mode	Sleep mode Position A1	Deep sleep Mode Position A2
Horizontal Sync	Active	Inactive	Active	Inactive
Vertical Sync	Active	Active	Inactive	Inactive
Video	Active	Blanked	Blanked	Blanked
Power Indicator	Green	Amber	Amber	Amber
Power Consumption	95W (max.)	Less than 8W	Less than 8W	Less than 8W

*Note this monitor automatically returns to normal operation when horizontal and vertical sync return. This occurs when you move the computer's mouse or press a key on the keyboard.*

This monitor is EPA ENERGY STAR® compliant and NUTEK® compliant when used with a computer equipped with VESA® DPMS functionality.

For energy conservation, turn your monitor OFF when it is not needed, or when leaving it unattended for long periods.

# Troubleshooting

Before calling for service, check the information in this section to see if you can remedy any problems quickly on your own.

**Table 1-4. Troubleshooting problems**

<b>Symptom</b>	<b>Corrective Actions</b>
No Picture	<ul style="list-style-type: none"><li>• Check to see that both the monitor and the computer are plugged in and turned on, and that correct input is selected.</li></ul>
“Check Signal Cable” appears	<ul style="list-style-type: none"><li>• Check the signal cable connection between the computer and the monitor.</li><li>• Use the monitor self test on page 10.</li></ul>
Picture appears to be ghosting	<ul style="list-style-type: none"><li>• Check the signal cable connection between the computer and monitor.</li></ul>
Screen image is not centered or sized properly	<ul style="list-style-type: none"><li>• Adjust the Horizontal and Vertical position settings using the OSM. See “Position” on page 16.</li><li>• Check Image Size selection. See “Image Size” on page 18.</li><li>• Run Auto Adjustment. See “Auto Adjustment - ANALOG (13W3) only” on page 8.</li></ul>
The power indicator is amber, and there is no image on screen	<ul style="list-style-type: none"><li>• The monitor is using its power management system. Check the power management utility on your computer.</li></ul>
The image is too light or too dark	<ul style="list-style-type: none"><li>• Adjust the Brightness. See “Brightness” on page 13.</li></ul>
Cannot adjust monitor with the buttons on the front panel	<ul style="list-style-type: none"><li>• Please contact Sun customer service.</li></ul>

**Table 1-4. Troubleshooting problems** *(continued)*

<b>Symptom</b>	<b>Corrective Actions</b>
Picture or text is fuzzy, degraded, or unstable.	<ul style="list-style-type: none"><li>• Not running in native mode can degrade the image. See “Image Size” on page 18.</li><li>• Perform monitor reset. See “Reset” on page 19.</li><li>• Analog mode: Perform ‘Auto Adjustment’ See “Auto Adjustment - ANALOG (13W3) only” on page 8.</li><li>• Resolution can be mismatched with respect to ‘Image Size’ selected. Native mode is recommended for clear screen image. See “Image Size” on page 18.</li><li>• Eliminate accessories. (i.e., video extension cables, etc.).</li></ul> <p><i>For optimal performance, use only the supplied Sun Microsystems video cables that are included with your 24.1-inch LCD Monitor.</i></p>

# Specifications

**Table 1-5. Specifications**

LCD Panel	24.067" (61.11 cm) viewable monitor 0.270 Pixel pitch
Synchronization	Horizontal: 31 kHz to 80 kHz (automatic) Vertical: 56 Hz to 76 Hz (automatic)
Maximum Resolution	1920 x 1200 Horizontal: 1920 pixels @ 82 kHz Vertical: 1200 lines @ 76 Hz Display colors: 16.7 million
Active Display	Horizontal: 20.43" (518.4 mm) Vertical: 12.77" (324.0 mm) (active display size is dependent upon signal timing and image size selection...default is native resolution 1:1)
Input Signal, Terminated	Analog video 0.7 Vp-p @t 75 Ω Separate sync, composite, and digital video T.M.D.S. (PaneLink™)
Maximum Pixel Clock	195 MHz (analog) ~ 151MHz (digital)
Power Adapter	AC 90-264 Volt, 60 Hz/50 Hz ± 3 Hz DC 14V/8A
Power Consumption*	95 W (maximum), 8 W (PowerSaver mode)
Dimensions/Weight	Unit: 23.2 x 20.4 max /18.4 x 10.9 min in (W x H x D); 29.54 lb 588 x 518/468 x 277 mm; 13.4 kg  Carton: 27.9 x 16.2 x 25.1 in (W x D x H); 16.76 lb (total weight 46.30 lbs./21.0kg.) 710 x 410 x 638 mm; 7.6 kg (All measurements approximate)
Environmental Considerations	Operating Temperature: 50°F to 104°F (10°C to 40°C) TBD Humidity: 10% to 80% Storage Temperature: -13°F to 113°F (-25°C to 45°C) TBD Humidity: 5% to 95%

*Note: Design and specifications are subject to change without prior notice.*

*\*Maximum power consumption is measured after allowing the unit to remain powered on for a minimum of 30 minutes so as to become thermally stable.*

# Pin Assignments

**Table 1-6. 13W3 connector**

Pin No.	13W3 Side of the Signal Cable	Pin No.	13W3 Side of the Signal Cable
A1	Red	5	Composite H.V Sync
A2	Green	6	DDC Data
A3	Blue	7	V-Sync
1	DDC Clock	8	NC
2	NC	9	
3		10	GND-Sync
4	Serial Data Return-+		

**Table 1-7. DVI-D connector**

*(Combined Analog and Digital Connector Pin Assignments)*

Pin No.	Signal Assignment	Pin No.	Signal Assignment	Pin No.	Signal Assignment
1	T.M.D.S. Data2-	9	T.M.D.S. Data1-	17	T.M.D.S. Data0-
2	T.M.D.S. Data2+	10	T.M.D.S. Data1+	18	T.M.D.S. Data0+
3	T.M.D.S. Data2/4 Shield	11	T.M.D.S. Data1/3 Shield	19	T.M.D.S. Data0/5 Shield
4	T.M.D.S. Data4-	12	T.M.D.S. Data3-	20	T.M.D.S. Data5-
5	T.M.D.S. Data4+	13	T.M.D.S. Data3+	21	T.M.D.S. Data5+
6	DDC Clock	14	+5V Power	22	T.M.D.S. Data Clock Shield
7	DDC Data	15	Ground (+5V, HSync, and VSync return)	23	T.M.D.S. Data Clock +
8	Analog Vertical Sync	16	Hot Plug Detect	24	T.M.D.S. Data Clock -



## Display Resolution

If the signal from the computer system is equal to a preset timing mode, screen resolution is adjusted automatically. If the signal from the system is not equal to a preset timing mode (there is no image on screen, and the LED on the front panel is amber), adjust the mode by referring to the setup poster (816-3263-10) supplied with your unit. See "Monitor Self Test - Analog and Digital" on page 10.

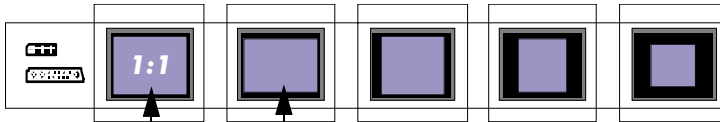

1920 x 1200 and 1920 x 1080 are the recommended modes

**Table 1-8. Preset timing modes - Primary/Secondary**

Display Mode	Horizontal Frequency (kHz)	Vertical Frequency (Hz)	Pixel Clock (MHz)	Sync Polarity (H/V)
1920 x 1200 Primary	73.54	60	151.200	Neg./Separate Pos./Composite
1920 x 1080 Secondary	66.97	60	137.700	Neg./Separate Pos./Composite

**Table 1-9. Preset timing modes - Alternate**

Display Mode	Horizontal Frequency (kHz)	Vertical Frequency (Hz)	Pixel Clock (MHz)	Sync Polarity (H/V)
1600 x 1200	TBD	60	132.000	TBD
1280 x 1024	63.98	60	108.000	Pos./Separate
1280 x 1024	81.13	76	135.000	Neg./Separate
1152 x 900	61.85	66	94.500	Neg./Composite
1152 x 900	74.57	76	132.000	Neg./Composite
1024 x 768	TBD	60	TBD	TBD
800 x 600	TBD	60	TBD	TBD
640 x 480	TBD	60	TBD	TBD

# Regulatory Information

## FCC Information

### User Instructions

The Federal Communications Commission Radio Frequency Interference Statement includes the following warning:

**Note:** This equipment has been tested and found to comply with the limits for a Class B digital device, pursuant to Part 15 of the FCC Rules. These limits are designed to provide reasonable protection against harmful interference in a residential installation. This equipment generates, uses, and can radiate radio frequency energy and, if not installed and used in accordance with the instructions, may cause harmful interference to radio communications. However, there is no guarantee that interference will not occur in a particular installation.

If this equipment does cause harmful interference to radio or television receptions, which can be determined by turning the equipment off and on, the user is encouraged to try to correct the interference by one or more of the following measures:

- Reorient or relocate the receiving antenna.
- Increase the separation between the equipment and receiver.
- Connect the equipment into an outlet on a circuit different from that to which the receiver is connected.
- Consult the dealer or an experienced radio/TV technician for help.

### User Information

Changes or modifications not expressly approved by the party responsible for compliance could void the user's authority to operate the equipment.

If necessary, consult your dealer or an experienced radio/television technician for additional suggestions. You may find the booklet called How to Identify and Resolve Radio/TV Interference Problems helpful. This booklet was prepared by the Federal Communications Commission. It is available from the U.S. Government Printing Office, Washington, DC 20402, Stock Number 004-000-00345-4.

### Warning

User must use shielded signal interface cables to maintain FCC compliance for the product.

### Declaration of conformity for products Marked with FCC Logo

This device complies with Part 15 of the FCC Rules. Operation is subject to the following two conditions: (1) this device may not cause harmful interference, and (2) this device must accept any interference received, including interference that may cause undesired operation.

The party responsible for product compliance:

SAMSUNG ELECTRONICS CO., LTD  
QA Lab of Samsung America  
85 West Tasman Drive  
San Jose, CA 95134 USA  
Tel) 408-544-5124  
Fax) 408-544-5191

Provided with this LCD is a detachable power supply cord with IEC320 style terminations. It may be suitable for connection to any UL Listed personal computer with similar configuration. Before making the connection, make sure the voltage rating of the computer convenience outlet is the same as the LCD and that the ampere rating of the

computer convenience outlet is equal to or exceeds the LCD voltage rating.

For 120 Volt applications, use only UL Listed detachable power cord with NEMA configuration 5-15P type (parallel blades)

plug cap. For 240 Volt applications use only UL Listed Detachable power supply cord with NEMA configuration 6015P type (tandem blades) plug cap.

## **IC Compliance Notice**

This Class B digital apparatus meets all requirements of the Canadian Interference-Causing Equipment Regulations of ICES-003.

Cet appareil Numérique de classe B respecte toutes les exigences du Règlement ICES-003 sur les équipements produisant des interférences au Canada.

## **MPR II Compliance**

This LCD complies with SWEDAC (MPR II) recommendations for reduced electric and magnetic fields.

## **European Notice**

Products with the CE Marking comply with both the EMC Directives (89/336/EEC), (92/31/EEC), (93/68/EEC) and the Low Voltage Directive (73/23/EEC) issued by the Commission of the European Community.

Compliance with these directives implies conformity to the following European Norms:

- EN55022 (CISPR 22): Radio disturbance characteristics
- EN55024 (CISPR 24): Immunity characteristics
- EN61000-3-2: Limits for harmonic current emissions
- EN61000-3-3:1995: Limitation of voltage fluctuations and flicker
- EN60950: 1997+A1+A2+A3+A4: Product Safety

## **VCCI Class 2 Notice (Japan Only)**

This equipment complies with the limits for a Class 2 digital device (devices used in or adjacent to a residential environment) and conforms to the standards for information technology equipment that are set by the Voluntary Control Council for Interference for preventing radio frequency interference in residential areas.

However, this equipment does generate, use, and can radiate radio frequency energy and, if not installed and used in accordance with the manufacturer's instruction manual, may cause interference with radio and television reception. Therefore, it is important to adhere to the manufacturer's instructions for installing and using this equipment.

この装置は、情報処理装置等電波障害自主規制協議会（VCCI）の基準に基づくクラスB情報技術装置です。この装置は、家庭環境で使用することを目的としていますが、この装置がラジオやテレビジョン受信機に近接して使用されると、受信障害を引き起こすことがあります。  
取扱説明書に従って正しく取り扱いをして下さい。