

**Sun StorEdge™ L25 Tape Library  
and  
Sun StorEdge™ L100 Tape Library**

**User's Guide**

**6423016-01**

**Ver. 1, Rel. 1**

Sun StorEdge™ L25 Tape Library and Sun StorEdge™ L100 Tape Library User's Guide, 6423016-01, Ver. 1, Rel. 1, June 2002, Made in USA.

Quantum Corporation provides this publication "as is" without warranty of any kind, either express or implied, including but not limited to the implied warranties of merchantability or fitness for a particular purpose. Quantum Corporation may revise this publication from time to time without notice.

### **COPYRIGHT STATEMENT**

© Copyright 2002 by Quantum Corporation. All rights reserved.

Your right to copy this document is limited by copyright law. Making copies or adaptations without prior written authorization of Quantum Corporation is prohibited by law and constitutes a punishable violation of the law.

### **TRADEMARK STATEMENT**

StackLink is a trademark of Quantum Corporation.

Sun StorEdge™ L25 Tape Library and Sun StorEdge™ L100 Tape Library are trademarks of Sun Microsystems, Inc.

Other trademarks may be mentioned herein which belong to other companies.

# Contents

---

---

<b>Preface</b>	<b>xiii</b>
----------------	-------------

---

<b>Chapter 1</b>	<b>Overview</b>	<b>1</b>
	Library Capacity .....	1
	L25 Library .....	1
	L100 Library .....	1
	SCSI Configuration .....	2
	Library Scalability .....	2
	Library Features .....	5
	Front Panel .....	5
	Internal Layout .....	9
	Back Panel .....	11

---

<b>Chapter 2</b>	<b>Basic Operations</b>	<b>13</b>
	Introduction .....	14
	Main Screen .....	14
	GUI Buttons .....	17
	GUI Icons .....	18

Using the Quick View Menu Screen.....	19
Accessing the Quick View Menu Screen .....	20
Viewing Library Information .....	20
Viewing Tape Drive Information .....	22
Viewing Inventory Information.....	23
Turning Drive Power On or Off (Quick View Menu Screen)..	24
Moving Tape Cartridges.....	26
Using the Mailbox .....	30
Viewing Mailbox Status .....	31
Importing and Exporting Cartridges .....	31
Configuring the Mailbox.....	37
Removing the Magazines .....	38
Removing a Magazine from an L25 .....	38
Removing a Magazine from an L100 .....	41
Viewing Statistics.....	45
Accessing the Statistics Menu Screen.....	45
Viewing Library Statistics.....	47
Viewing Drive Statistics .....	48
Viewing the SCSI History .....	49
Viewing the Stack Configuration .....	50

---

**Chapter 3                      Changing the Library Configuration                      53**

Accessing the Configuration Screen .....	53
Setting the Library ID.....	55
Changing a Tape Drive ID .....	56
Changing the Terminator Power Setting .....	58
Changing the Emulation Setting .....	59
Changing the Sync Negotiation Setting .....	60
Changing the Wide Negotiation Setting .....	61
Changing the Serialization Setting.....	62
Changing the Short Labels Setting.....	63
Changing the Illumination Setting.....	64
Changing the Off-Line Time Setting.....	65
Changing the Barcode Scanner Setting .....	66

	Changing the Baud Rate Setting .....	67
	Setting the Time .....	67
	Setting the Date.....	68
	Changing the Import/Export Setting.....	69
	Changing the Auto-Clean Setting .....	72
	Changing the Ignore Host Lock Setting.....	73
	Changing the Auto-Import Option.....	74
<b>Chapter 4</b>	<b>Performing Maintenance Operations</b>	<b>77</b>
	Accessing the Maintenance Screen .....	77
	Cleaning a Tape Drive .....	79
	Turning Drive Power On or Off (Maintenance Screen).....	81
	Adjusting the Contrast.....	83
<b>Chapter 5</b>	<b>Running Diagnostic Programs</b>	<b>85</b>
	Accessing the Diagnostics Menu Screen .....	85
	Running the Barcode Scanner Test .....	87
	Running the Move Medium Test .....	89
	Running the Move Location Test .....	92
	Running the Display Test.....	95
<b>Chapter 6</b>	<b>Running the Demonstration Programs</b>	<b>97</b>
	Accessing the Demo Programs Screen .....	97
	Running the Confidence Test Program.....	98
	Running the Demo 1 Program.....	99
	Running the Demo 2 Program.....	100
	Running the Demo 3 Program.....	101
	Running the Demo 4 Program.....	102
	Running the Demo 5 Program.....	103
	Running the Demo 6 Program.....	104

<b>Appendix A</b>	<b>Specifications</b>	<b>105</b>
	Physical Specifications .....	106
	Performance Specifications .....	107
	Reliability Specifications.....	108
	Tape Drive Specifications .....	109
	Environmental Specifications .....	109
<b>Appendix B</b>	<b>Fault Symptom Code (FSC) Dictionary</b>	<b>111</b>
<b>Appendix C</b>	<b>DLTtape Cartridge Maintenance</b>	<b>159</b>
	Handling DLTtape Cartridges.....	159
	Visual Inspection of DLTtape Cartridges .....	160
	When To Visually Inspect a DLTtape Cartridge .....	160
	Visual Inspection Procedure.....	161
<b>Appendix D</b>	<b>Regulatory Statements</b>	<b>165</b>
<b>Glossary</b>		<b>171</b>
<b>Index</b>		<b>173</b>

# Figures

---

Figure 1	L25 Front Panel .....	6
Figure 2	L100 Front Panel .....	7
Figure 3	L25 Internal Layout .....	9
Figure 4	L100 Internal Layout .....	10
Figure 5	L25 Back Panel.....	11
Figure 6	L100 Back Panel.....	12
Figure 7	Sample Main Screen, Stand-alone L25.....	15
Figure 8	Sample Main Screen, L25 in a Multiple Library Stack .....	16
Figure 9	L100 Library Levels .....	16
Figure 10	Sample Main Screen, L100.....	17
Figure 11	Using the GUI Buttons .....	17
Figure 12	Quick View Menu Screen .....	20
Figure 13	Sample Library Information Screen .....	21
Figure 14	Sample Drive Information Screen .....	22
Figure 15	Sample Inventory Screen .....	23

Figure 16	Sample Drive Power Screen .....	24
Figure 17	Sample Drive Power Screen .....	25
Figure 18	Menu Screen .....	26
Figure 19	Sample Move Cartridge FROM Screen.....	27
Figure 20	Sample Move Cartridge TO Screen.....	28
Figure 21	Sample Confirm Move Cartridge Screen.....	29
Figure 22	Sample Mailbox Screen .....	30
Figure 23	Mailbox - OPEN Screen.....	32
Figure 24	Sample Release Magazines Screen .....	39
Figure 25	Magazine Release Button.....	40
Figure 26	Release Magazines Screen .....	41
Figure 27	Removing the Level 2 Left Magazine .....	43
Figure 28	Pressing the Release Latch.....	44
Figure 29	Removing the Level 1 Left Magazine .....	44
Figure 30	Service Menu Screen.....	46
Figure 31	Statistics Menu Screen.....	46
Figure 32	Sample Library Statistics Screen.....	47
Figure 33	Sample Drive Statistics Screen .....	48
Figure 34	Sample SCSI History Screen.....	49
Figure 35	Sample Stack Configuration Screen .....	51
Figure 36	Menu Screen .....	54
Figure 37	Configuration Screen.....	54
Figure 38	L100 Drive Numbering .....	56
Figure 39	Service Menu Screen.....	78
Figure 40	Maintenance Screen.....	78
Figure 41	Select Cleaning Cartridge Screen.....	79
Figure 42	Select Tape Drive Screen.....	80



Figure 43	Sample Drive Power Screen .....	81
Figure 44	Drive Power Screen .....	82
Figure 45	Adjust Contrast Screen.....	83
Figure 46	Service Menu Screen.....	86
Figure 47	Diagnostics Menu Screen.....	86
Figure 48	Diags: General Screen.....	87
Figure 49	Diag: Barcode Screen.....	88
Figure 50	Sample Move Cartridge FROM Screen.....	89
Figure 51	Move Cartridge TO Screen.....	90
Figure 52	Sample Confirm Move Cartridge Screen .....	91
Figure 53	Diag: Move Medium Screen.....	91
Figure 54	Diag: Move-Location Screen .....	93
Figure 55	Diag: Move Location Screen.....	94
Figure 56	Demo Programs Screen.....	98
Figure 57	Location of the Reel Locks and the Hub.....	161
Figure 58	Opening the Tape Cartridge Door .....	162
Figure 59	Write Protect Switch.....	163
Figure 60	Declaration of Conformity, L25 .....	169
Figure 61	Declaration of Conformity, L100 .....	170



# Tables

---

Table 1	Capacity, L25 Multiple Library Stack .....	3
Table 2	Capacity, L100 Multiple Library Stack .....	4
Table 3	Front Panel Features .....	8
Table 4	GUI Icons .....	18
Table 5	Import/Export Settings.....	70
Table 6	Unit Dimensions/Weight.....	106
Table 7	Capacities .....	106
Table 8	Performance Specifications .....	107
Table 9	Library Performance.....	108
Table 10	Reliability Specifications.....	108
Table 11	Tape Drive Specifications .....	109
Table 12	Power .....	109
Table 13	Climate .....	109
Table 14	Compliance and Certification .....	110
Table 15	Fault Symptom Codes.....	111



# Preface

---

This document describes the Sun StorEdge™ L25 Tape Library and the Sun StorEdge™ L100 Tape Library. Hereafter in this document, these libraries are referred to as the L25 and the L100, respectively.

---

**Audience**

This document is written for operators of the L25 and L100 libraries.

---

**Purpose**

This document explains how to use the L25 and L100 libraries.

---

**Document Organization**

This document is organized as follows:

- [Chapter 1, Overview](#), provides an overview of the L25 and L100 libraries.
- [Chapter 2, Basic Operations](#), introduces the library GUI screens and explains how to use them to perform basic library operations such as moving tape cartridges within the library, removing the tape cartridge magazines, and viewing library information.

- [Chapter 3, Changing the Library Configuration](#), explains how to change the library configuration using the GUI **Configuration** screen.
- [Chapter 4, Performing Maintenance Operations](#), explains how to perform library maintenance operations using the GUI **Maintenance** screen.
- [Chapter 5, Running Diagnostic Programs](#), explains how to use the library's built in diagnostic programs.
- [Chapter 6, Running the Demonstration Programs](#), explains how to run the library demonstration programs.
- [Appendix A, Specifications](#), lists the specifications for the L25 and L100 libraries.
- [Appendix B, Fault Symptom Code \(FSC\) Dictionary](#), lists the fault symptom codes (FSCs) for the L25 and L100 libraries.
- [Appendix C, DLTape Cartridge Maintenance](#), provides guideline for handling DLT cartridges and visually inspecting them if necessary.
- [Appendix D, Regulatory Statements](#), provides regulatory information for the L25 and L100 libraries.

This document concludes with a glossary and a detailed index.

---

## Notational Conventions

This document uses the following conventions:

**Note:** Notes emphasize important information related to the main topic.

**Tech Tip:** Tech Tips provide technical information that may be helpful in performing the procedure.

**Caution:** Cautions indicate potential hazards to equipment and are included to prevent damage to equipment.

**Warning:** Warnings indicate potential hazards to personal safety and are included to prevent injury.

This manual uses the following:

- Right side of the library – Refers to the right side as you face the component being described.
- Left side of the library – Refers to the left side as you face the component being described.

## Related Documents

Documents related to the L25 and L100 libraries are shown below.

### L25 and L100 Documentation

Document No.	Title	Description
6421029	<i>Sun StorEdge™ L25 Tape Library Unpacking Instructions</i>	This document explains how to remove the L25 library from the shipping carton.
6423014	<i>Sun StorEdge™ L100 Tape Library Unpacking Instructions</i>	This document explains how to remove the L100 library from the shipping carton.
6423015	<i>Sun StorEdge™ L25 Tape Library and Sun StorEdge™ L100 Tape Library Installation Guide</i>	This document explains how to install an L25 or L100 library.

<b>Document No.</b>	<b>Title</b>	<b>Description</b>
6421031	<i>Sun StorEdge™ L25 Tape Library Regulatory Statements</i>	This document provides regulatory information for the L25 library.
6423018	<i>Sun StorEdge™ L100 Tape Library Regulatory Statements</i>	This document provides regulatory information for the L100 library.

Refer to the appropriate product manuals for information about your tape drive and cartridges.

### **SCSI-2 Specification**

The SCSI-2 communications specification is the proposed American National Standard for information systems, dated March 9, 1990. Copies may be obtained from:

Global Engineering Documents  
 15 Inverness Way, East  
 Englewood, CO 80112  
 (800) 854-7179 or (303) 397-2740



# Chapter 1

## Overview

---

This chapter provides an overview of the L25 and L100 libraries and their features.

---

## Library Capacity

---

### L25 Library

The L25 library can contain up to two tape drives and up to 21 DLT/SDLT cartridges or 25 LTO cartridges. The cartridges are stored in two independently removable cartridge magazines and one fixed cartridge slot.

---

### L100 Library

The L100 library can contain:

- Up to five tape drives and up to 84 DLT/SDLT cartridges or 100 LTO cartridges
- Six tape drives and up to 73 DLT/SDLT cartridges or 87 LTO cartridges

The cartridges are stored in up to eight independently removable cartridge magazines and up to four fixed cartridge slots.

---

## SCSI Configuration

The L25 and L100 library modules come configured for HVD SCSI. One SCSI bus is provided for the library robotics and for each tape drive installed. These SCSI buses are SCSI-2 fast/wide (8/16 bit).

---

## Library Scalability

The L25 and L100 library modules can be used as stand-alone libraries, or can be combined with other L25 and L100 library modules and a StackLink mechanism in a standard 19-inch rack to form a larger library system (called a multiple library stack). The multiple library stack appears as a single large capacity library to the host.

The StackLink mechanism connects the library modules in the multiple library stack and transports cartridges from module to module. Each tape drive has access to all the tape cartridges in the stack.

Once the StackLink mechanism is installed in the rack, you can add library modules simply by sliding them into place and making the necessary electrical connections.

[Table 1](#) lists the capacities of all the sizes of multiple library stack you can create using L25 library modules. [Table 2](#) lists the capacities of all the sizes of multiple library stack you can create using L100 library modules. You can obtain different capacities by combining L25 and L100 library modules in a multiple library stack.

Table 1 Capacity, L25  
Multiple Library Stack

# of L25 Library Modules	Max. # of Tape Drives	# of Cartridges*		Capacity*		
		DLT/SDLT	LTO	DLT	SDLT	LTO
1	2	21	25	.8 TB native, up to 1.6 TB compressed	2.2 TB native, up to 4.4 TB compressed	2.4 TB native, up to 4.8 TB compressed
2	4	42	50	1.6 TB native, up to 3.2 TB compressed	4.4 TB native, up to 8.8 TB compressed	4.8 TB native, up to 9.6 TB compressed
3	6	63	75	2.4 TB native, up to 4.8 TB compressed	6.6 TB native, up to 13.2 TB compressed	7.2 TB native, up to 14.4 TB compressed
4	8	84	100	3.2 TB native, up to 6.4 TB compressed	8.8 TB native, up to 17.6 TB compressed	9.6 TB native, up to 19.2 TB compressed
5	10	105	125	4 TB native, up to 8 TB compressed	11.0 TB native, up to 22.0 TB compressed	12.0 TB native, up to 24.0 TB compressed
6	12	126	150	4.8 TB native, up to 9.6 TB compressed	13.2 TB native, up to 26.4 TB compressed	14.4 TB native, up to 28.8 TB compressed
7	14	147	175	5.6 TB native, up to 11.2 TB compressed	15.4 TB native, up to 30.8 TB compressed	16.8 TB native, up to 33.6 TB compressed

# of L25 Library Modules	Max. # of Tape Drives	# of Cartridges*		Capacity*		
		DLT/SDLT	LTO	DLT	SDLT	LTO
8	16	168	200	6.4 TB native, up to 12.8 TB compressed	17.6 TB native, up to 35.2 TB compressed	19.2 TB native, up to 38.4 TB compressed
9	18	189	225	7.2 TB native, up to 14.4 TB compressed	19.8 TB native, up to 39.6 TB compressed	21.6 TB native, up to 43.2 TB compressed

\* The values in the **# of Cartridges** and **Capacity** columns assume that all the magazines are fully populated with data cartridges, and that the fixed cartridge slots are populated with cleaning cartridges.

Table 2 Capacity, L100 Multiple Library Stack

# of L100 Library Modules	# of Tape Drives	Max. # of Cartridges*		Capacity*		
		DLT/SDLT	LTO	DLT	SDLT	LTO
1	0-5	84	100	3.2 TB native, up to 6.4 TB compressed	8.8 TB native, up to 17.6 TB compressed	9.6 TB native, up to 19.2 TB compressed
	6	73	87	2.8 TB native, up to 5.6 TB compressed	7.7 TB native, up to 15.4 TB compressed	8.4 TB native, up to 16.8 TB compressed

# of L100 Library Modules	# of Tape Drives	Max. # of Cartridges*		Capacity*		
		DLT/SDLT	LTO	DLT	SDLT	LTO
2	0-10	168	200	6.4 TB native, up to 12.8 TB compressed	17.6 TB native, up to 35.2 TB compressed	19.2 TB native, up to 38.4 TB compressed
	11	157	187	6 TB native, up to 12 TB compressed	16.5 TB native, up to 33 TB compressed	18 TB native, up to 36 TB compressed
	12	146	174	5.6 TB native, up to 11.2 TB compressed	15.4 TB native, up to 30.8 TB compressed	16.8 TB native, up to 33.6 TB compressed

\* The values in the **# of Cartridges** and **Capacity** columns assume that all the magazines are fully populated with data cartridges, and that the fixed cartridge slots are populated with cleaning cartridges.

## Library Features

### Front Panel

[Figure 1](#) illustrates the features of the L25 library front panel.  
[Figure 2](#) illustrates the features of the L100 library front panel.

These features are described in [table 3](#).

Figure 1 L25 Front  
Panel

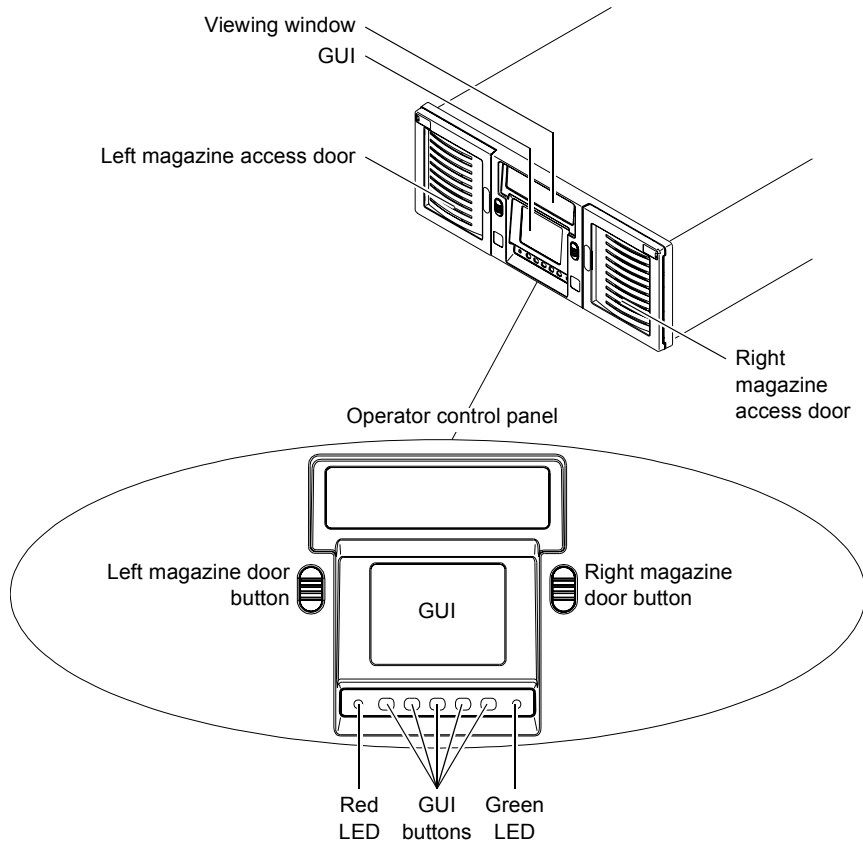

Figure 2 L100 Front Panel

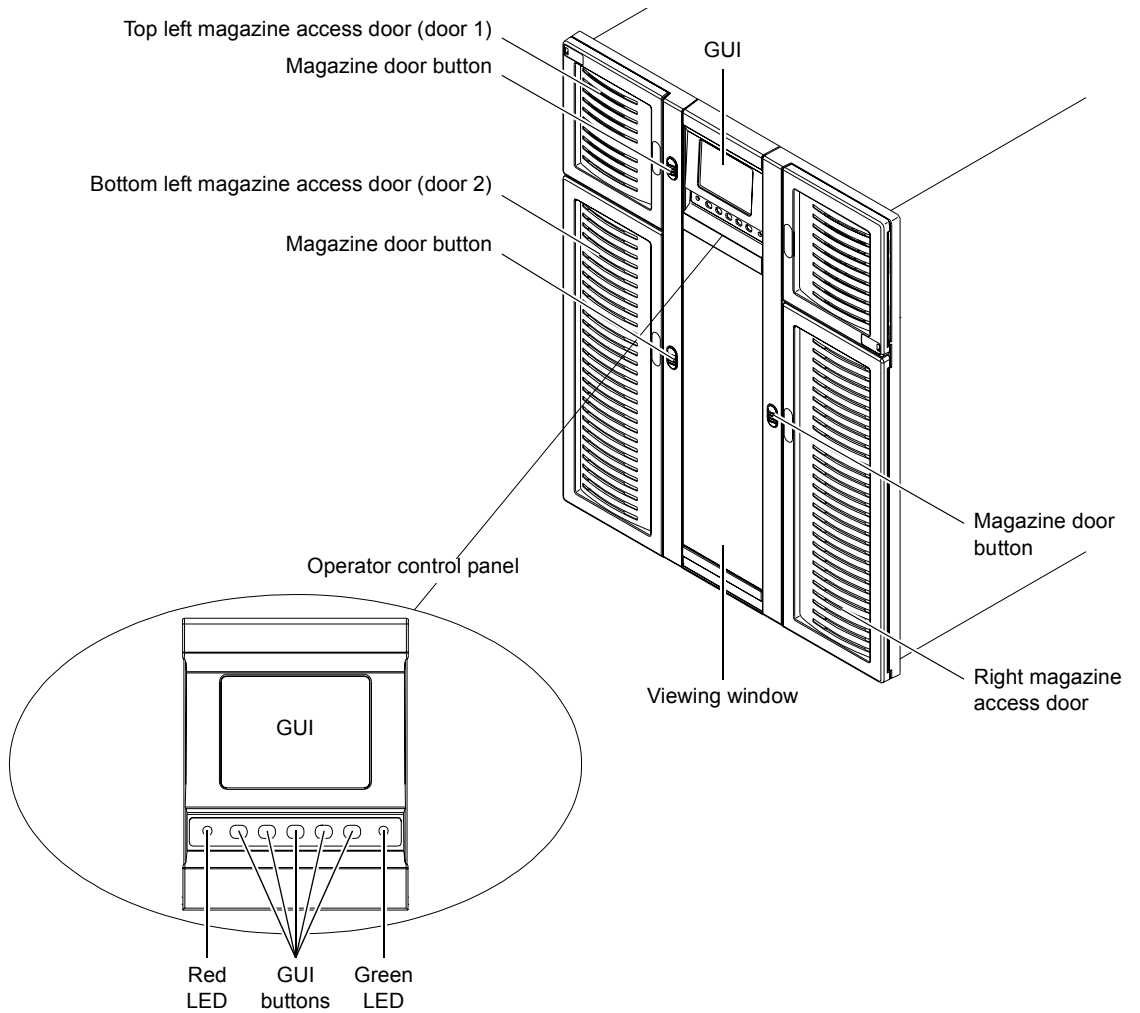

Table 3 Front Panel  
Features

Feature	Description
Operator control panel	<p>The operator control panel consists of the following elements:</p> <ul style="list-style-type: none"> <li data-bbox="305 430 1219 600">• Graphical user interface (GUI) The GUI displays library status information and allows you to access the library menus. These menus allow you to view or change the library settings, run demonstration programs, or run diagnostic tests. The GUI is discussed in detail in this book.</li> <li data-bbox="305 631 1196 756">• Five GUI buttons Use these buttons in combination with the GUI to scroll through screens and select options or commands. The functionality of these buttons changes depending on the currently displayed GUI screen.</li> <li data-bbox="305 788 1190 913">• Magazine door buttons Pressing these buttons opens the magazine doors, if the magazines have already been released using the <b>Mags</b> option on the GUI (see <a href="#">Removing the Magazines</a> on page 38).</li> <li data-bbox="305 944 1219 1343">• Light emitting diode (LED) indicators The operator control panel has two LED indicators: <ul style="list-style-type: none"> <li data-bbox="544 996 1190 1208">• The green LED lights when the library is fully operational and ready to accept host commands. It flashes while the library is transitioning from a READY state to a NOT READY state. The library will not be READY during power-on self-tests, when magazines are being released, or during access to certain menu items.</li> <li data-bbox="544 1239 1129 1260">• The red LED lights when there is a library error.</li> <li data-bbox="544 1291 1143 1343">• Both LEDs flash when there is a library fault that requires operator attention.</li> </ul> </li> </ul>
Magazine access doors	These doors protect the data cartridge magazines.
Viewing window	This window allows you to view the library robotics while the library is operating.



---

**Internal Layout**

[Figure 3](#) illustrates the internal layout of an L25 library. [Figure 4](#) illustrates the internal layout of an L100 library.

---

Figure 3 L25 Internal  
Layout

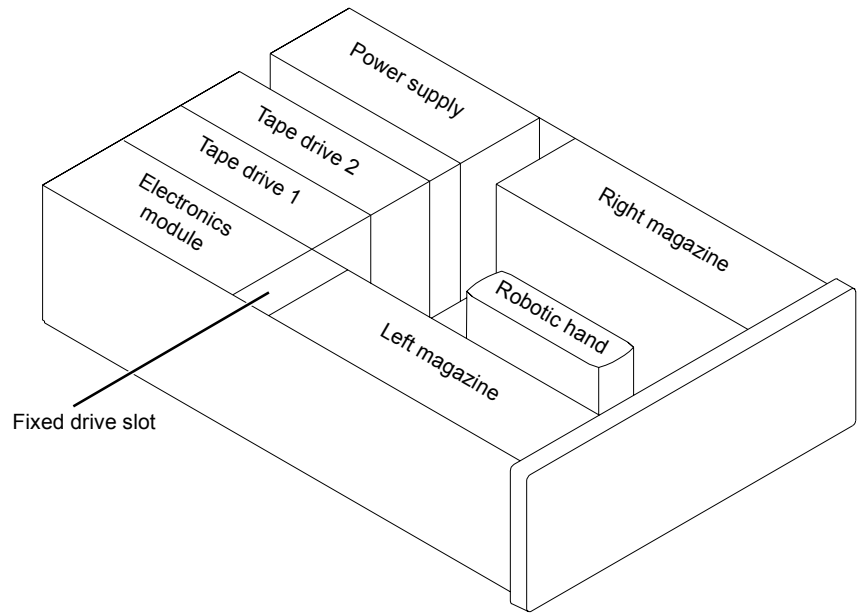
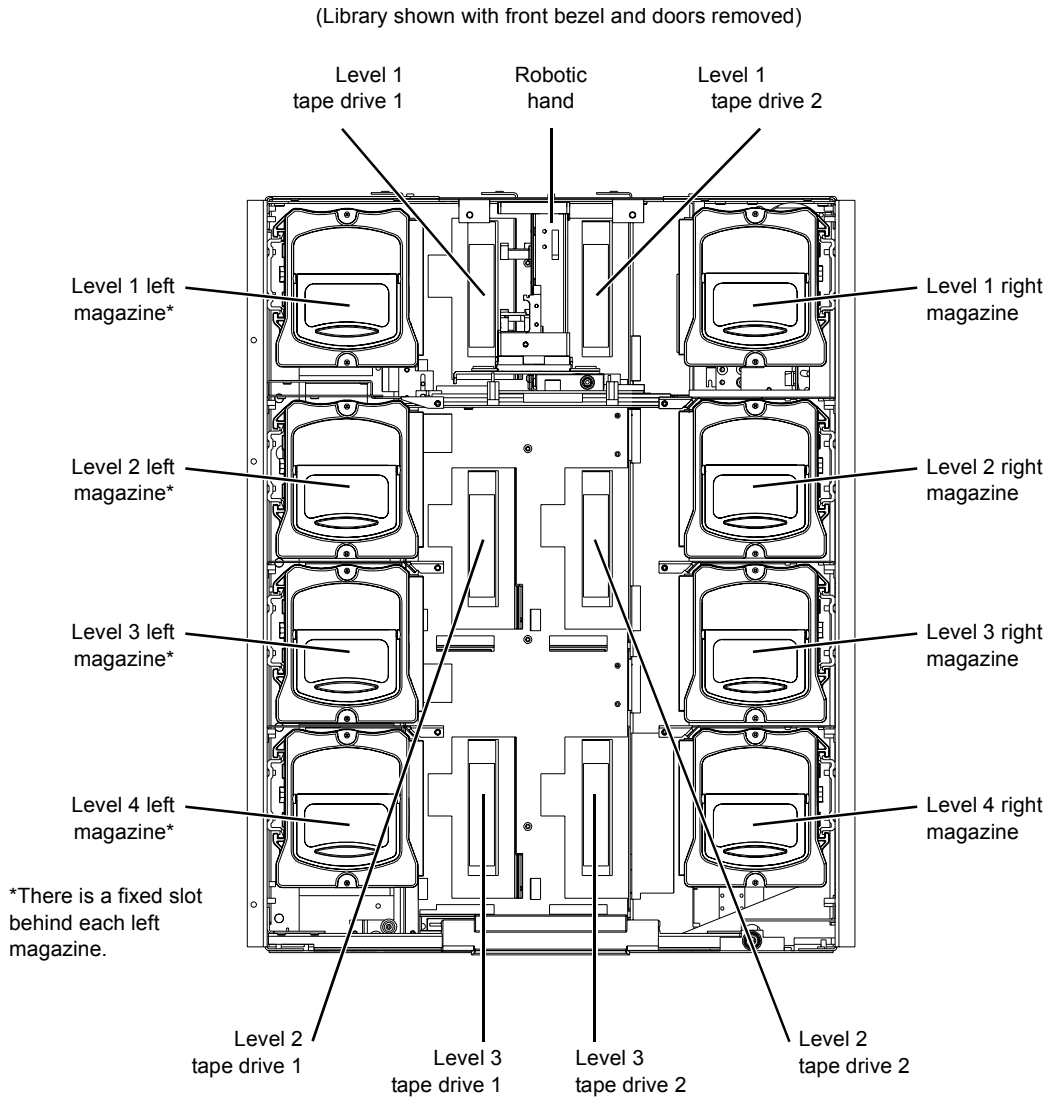

Figure 4 L100 Internal  
Layout



Each cartridge magazine holds 10 DLT/SDLT cartridges or 12 LTO cartridges. The bins in the left magazines are numbered from 1 through 10 (or 12 in LTO libraries) from front to back. The bins in the right magazines are numbered from 1 through 10 (or 12 in LTO libraries) from back to front.

The L25 has one fixed cartridge slot behind the left magazine. The L100 has four fixed cartridge slots, one behind each left magazine. The fixed cartridge slots can be used as additional data cartridge bins, or can be used to hold cleaning tapes, which can be moved to a tape drive when cleaning is required.

A bar code reader is attached to the library's robotic hand. This bar code reader automatically identifies the cartridges in the library, if the cartridges are fitted with acceptable bar code labels.

## Back Panel

[Figure 5](#) illustrates the back panel of the L25 library. [Figure 6](#) illustrates the back panel of the L100 library.

Figure 5 L25 Back Panel

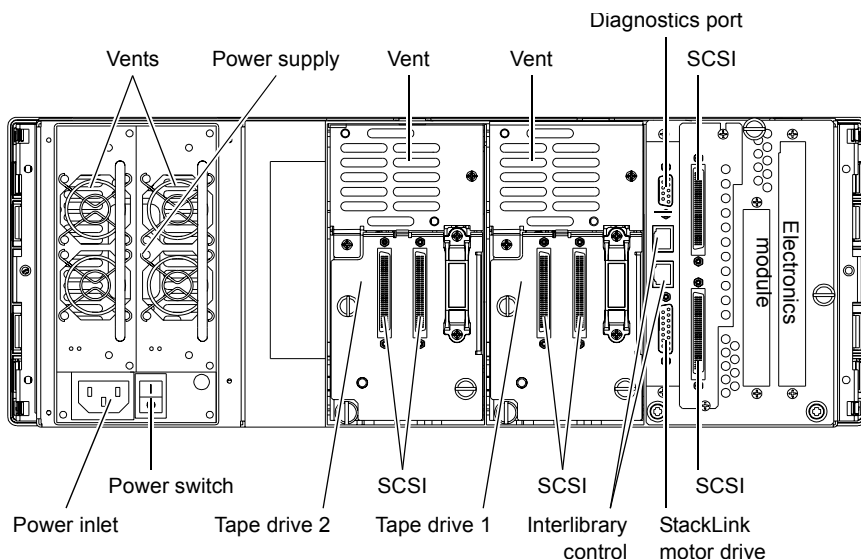
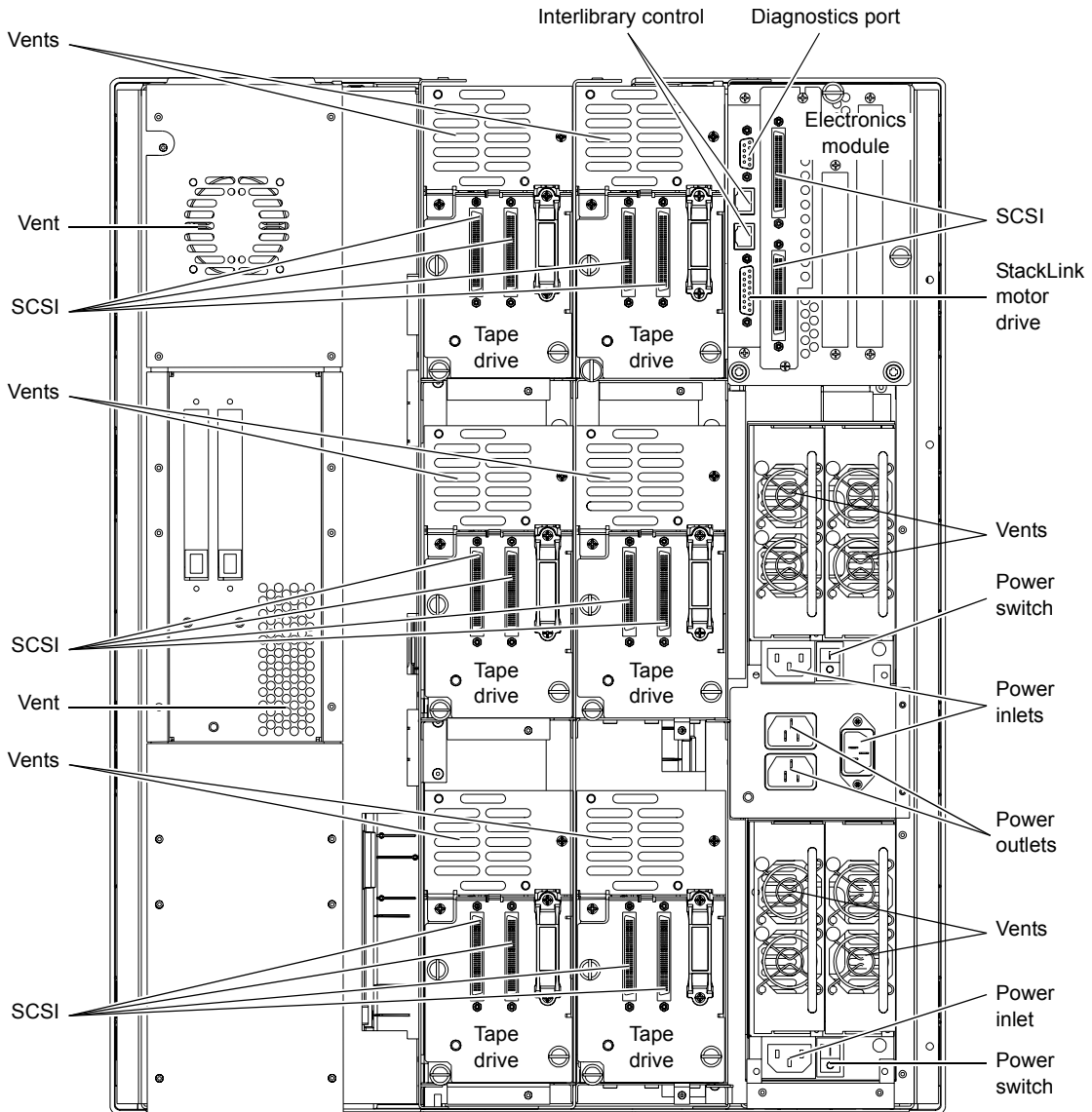

Figure 6 L100 Back  
Panel



## Chapter 2

# Basic Operations

---

This chapter introduces the library GUI screens and explains how to use them to perform the following basic library operations:

- Viewing library information (see [Using the Quick View Menu Screen](#) on page 19)
- Moving tape cartridges within the library (see [Moving Tape Cartridges](#) on page 26)
- Using the mailbox (see [Using the Mailbox](#) on page 30)
- Removing the tape cartridge magazines (see [Removing the Magazines](#) on page 38)
- View library, drive and SCSI statistics (see [Viewing Statistics](#) on page 45)
- Viewing the configuration of the entire library and stack, if the library is part of a multiple library stack (see [Viewing the Stack Configuration](#) on page 50)

---

## Introduction

Before using the GUI to perform library functions, familiarize yourself with the:

- Main screen
- GUI buttons
- GUI icons

---

### Main Screen

The first screen the GUI displays after library initialization is the main screen. This screen displays library status and provides inventory information for the cartridge magazines, the fixed slot(s), the drives, and the robotic hand. It also provides access to the library menus. It updates in real time as cartridges move within the library.

The main screen appears somewhat different depending on whether the library is an:

- L25 stand-alone library
- L25 library in a multiple library stack
- L100 library

If the library is a stand-alone L25, the main screen appears as shown in [figure 7](#).

Figure 7 Sample Main  
Screen, Stand-alone  
L25

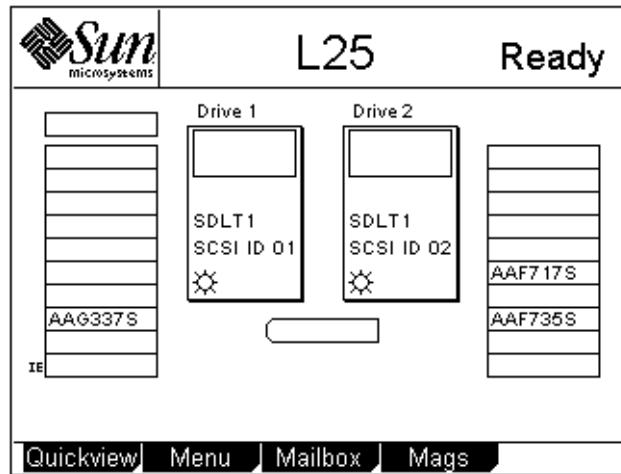

If the library is an L25 and is part of a multiple library stack, the main screen displays the level of the L25 module and provides an additional button, the **Stack** button (see [figure 8](#)).

**Note:** In a multiple library stack, each L25 library module is considered one “level” of the library. Each L100 library module is considered four levels of the library (see [figure 9](#)). Levels are numbered from top to bottom, starting with 1.

Figure 8 Sample Main Screen, L25 in a Multiple Library Stack

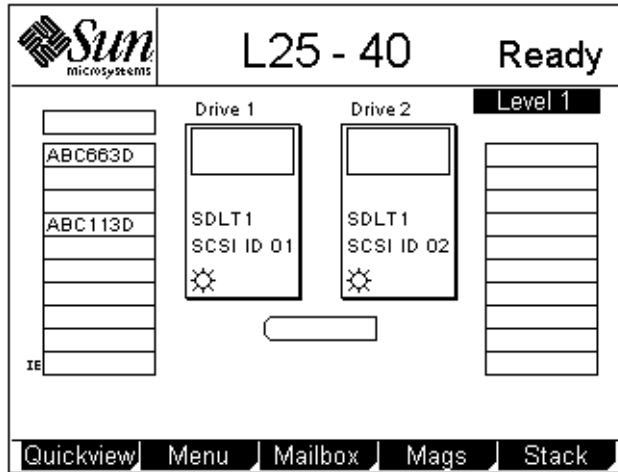

If the library is an L100, the first main screen provides a **Level** button and displays information about the top level of the L100 (see [figure 9](#) and [figure 10](#)). To view main screens for the other levels within the L100, press the **Level** button.

Figure 9 L100 Library Levels

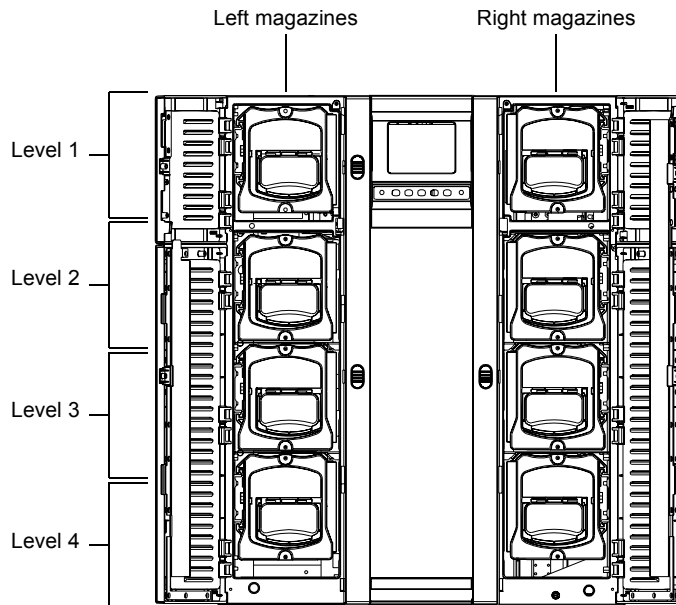
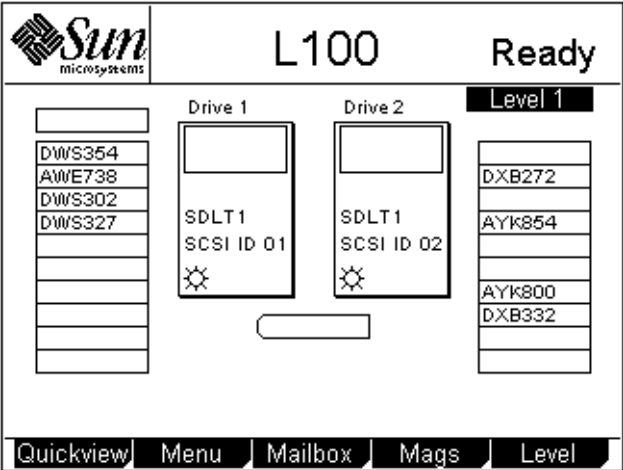



Figure 10 Sample  
Main Screen, L100



**GUI Buttons**

At the bottom of each GUI screen are up to five button labels. These labels indicate the functions of the five push buttons below the GUI. To select a function, press the push button directly below the button label on the GUI screen (see [figure 11](#)).



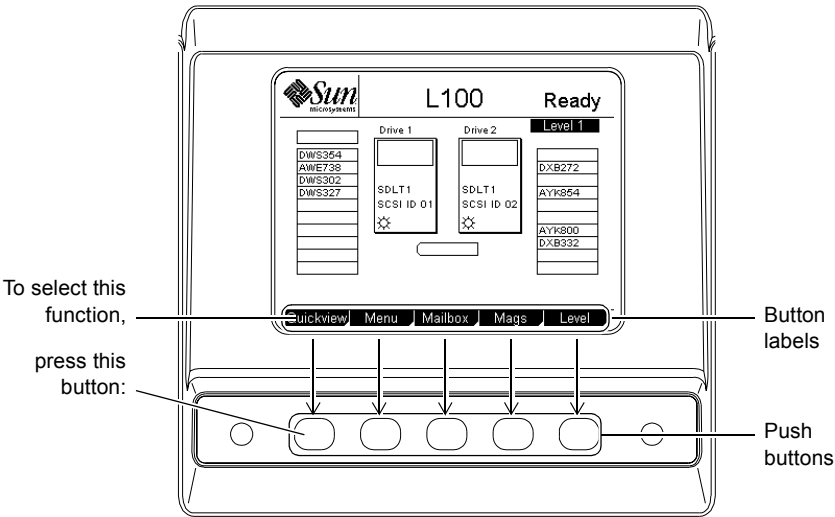

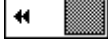
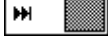





Figure 11 Using the  
GUI Buttons





**GUI Icons**

[Table 4](#) explains the meaning of each of the GUI icons.

Table 4 GUI Icons

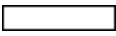
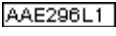
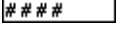
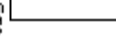
Icon	Meaning
	No tape present
	Tape loading
	Tape unloading
	Tape unloaded
	Tape idle
	Tape rewinding
	Locating data
	Reading data
	Writing data
	Power on
	Drive fault
	Tape is write-protected
	Drive needs cleaning

Icon	Meaning
	Slot empty
	Slot occupied
	Slot occupied - no label or bad bar code
	1 slot mailbox - NOT SCSI import/export element
	Mailbox slot and SCSI import/export element

## Using the Quick View Menu Screen

The **Quick View Menu** screen allows you to view information about the library, drives, and inventory without placing the library in a NOT READY state.

**Note:** The **Quick View Menu** screen allows you to view the current library configuration only; you cannot make any changes to the configuration.

---

### Accessing the Quick View Menu Screen

To access the **Quick View Menu** screen, press **Quickview** on the main screen. The GUI displays the **Quick View Menu** screen (see [figure 12](#)).

---

Figure 12 Quick View Menu Screen

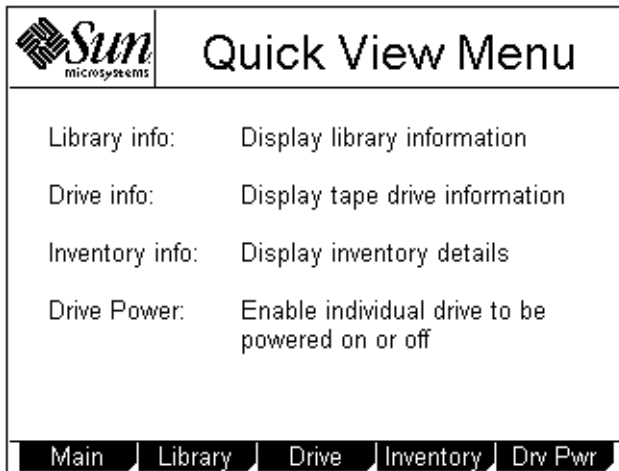

---

### Viewing Library Information

To view library information using the **Quick View Menu** screen:

- 1 Access the Quick View Menu screen (see [Accessing the Quick View Menu Screen](#)).
- 2 Press **Library**.

The GUI displays the **Library Information** screen (see [figure 13](#)).

Figure 13 Sample  
Library Information  
Screen

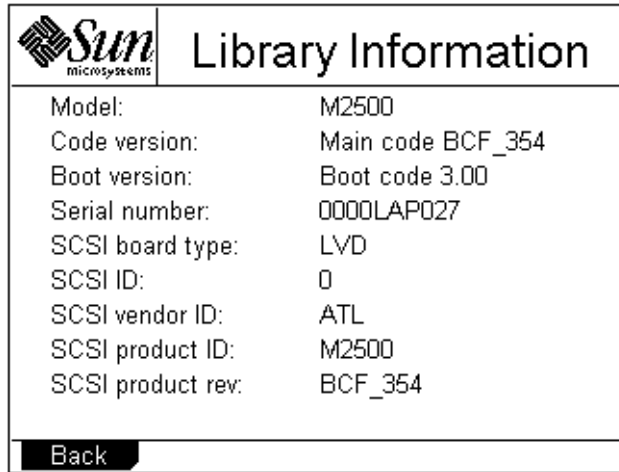

Library Information	
Model:	M2500
Code version:	Main code BCF_354
Boot version:	Boot code 3.00
Serial number:	0000LAP027
SCSI board type:	LVD
SCSI ID:	0
SCSI vendor ID:	ATL
SCSI product ID:	M2500
SCSI product rev:	BCF_354

Back

The **Library Information** screen displays the following information about the library:

- Model
  - Code version
  - Boot version
  - Serial number
  - SCSI board type
  - SCSI ID
  - SCSI vendor ID
  - SCSI product ID
  - SCSI product revision
- 3** When you are finished viewing library information, press **Back** to return to the **Quick View Menu** screen.

## Viewing Tape Drive Information

To view tape drive information using the **Quick View Menu** screen:

- 1 Access the **Quick View Menu** screen (see [Accessing the Quick View Menu Screen](#)).
- 2 Press **Drive**.

The GUI displays the **Drive Information** screen (see [figure 14](#)).

Figure 14 Sample Drive Information Screen

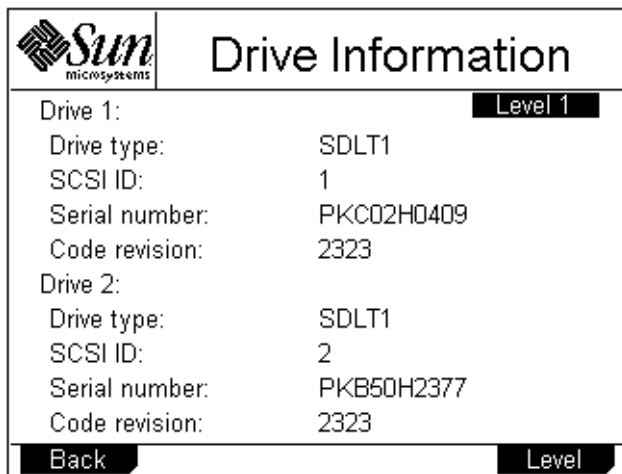

The **Drive Information** screen displays the following information about each drive installed in the library module:

- Drive type
- SCSI ID
- Serial number
- Code revision

**Note:** If the library is an L100, this screen displays a **Level** button. Pressing this button displays drive information for each library level within the L100.

- 3 When you are finished viewing drive information, press **Back** to return to the **Quick View Menu** screen.

## Viewing Inventory Information

To view inventory information using the **Quick View Menu** screen:

- 1 Access the **Quick View Menu** screen (see [Accessing the Quick View Menu Screen](#) on page 20).
- 2 Press **Inventory**.

The GUI displays the **Inventory** screen (see [figure 15](#)).

Figure 15 Sample Inventory Screen

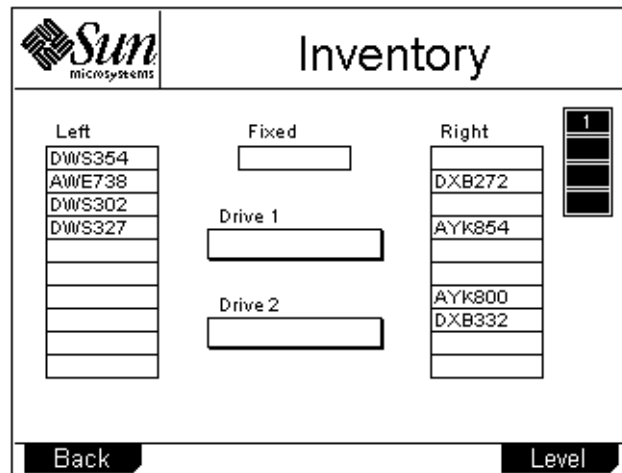

The **Inventory** screen provides a graphical representation of the library inventory.

**Note:** If the library is an L25 in a multiple library stack or an L100, this screen displays a **Level** button. Pressing this button displays inventory information for other library levels.

- 3 When you are finished viewing inventory information, press **Back** to return to the **Quick View Menu** screen.

### Turning Drive Power On or Off (Quick View Menu Screen)

The **Drive Power** option allows you to turn drive power on or off from the GUI. Use this option to turn off drive power when you are hot-swapping a tape drive.

**Note:** This option is available on both the **Quick View Menu** screen and the **Maintenance** screen. To access this option on the **Maintenance** screen, refer to [Turning Drive Power On or Off \(Maintenance Screen\)](#) on page 81.

### Turning Drive Power On or Off in an L25 Library

To turn drive power on or off in an L25 library:

- 1 Access the **Quick View Menu** screen (see [Accessing the Quick View Menu Screen](#) on page 20).
- 2 Press **Drv Pwr**.

The GUI displays the **Drive Power** screen (see [figure 16](#)).

Figure 16 Sample Drive Power Screen

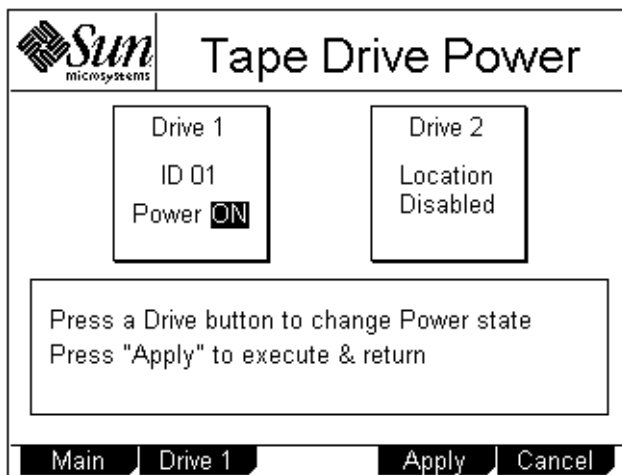

- 3 Press the button that corresponds to the drive you wish to power on or off: **Drive 1** or **Drive 2**.



The GUI displays the currently selected setting in the tape drive box at the top of the screen.

- 4 Press **Apply** to save the change and return to the **Quick View Menu** screen.

To return to the **Quick View Menu** screen without changing the power state of the drive, press **Cancel**.

### Turning Drive Power On or Off in an L100 Library

To turn drive power on or off in an L100 library:

- 1 Access the **Quick View Menu** screen (see [Accessing the Quick View Menu Screen](#) on page 20).
- 2 Press **Drv Pwr**.

The GUI displays the **Drive Power** screen (see [figure 17](#)).

Figure 17 Sample  
Drive Power Screen

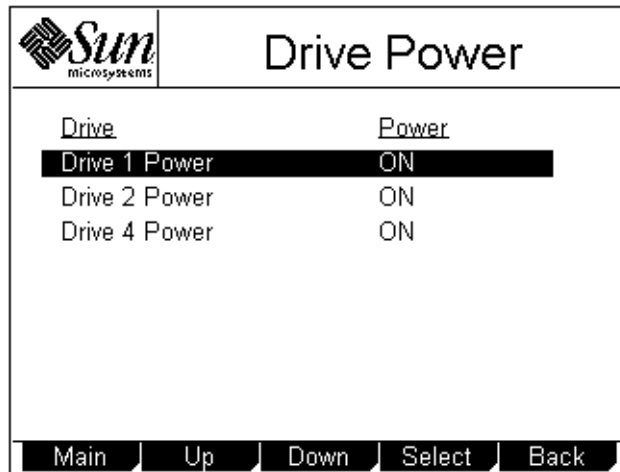

- 3 Press the **Up** or **Down** buttons to highlight the drive you wish to power on or off.

4 Press **Select**.

The drive power setting is highlighted.

5 Press the **Up** or **Down** buttons to change the current setting.

6 When the desired setting is displayed, press **Select**.

To exit this screen without changing the drive power setting, press **Cancel**.

7 Press **Back** to save the change and return to the **Quick View Menu** screen.

---

## Moving Tape Cartridges

To move tape cartridges within the library:

1 On the main screen, press **Menu**.

The GUI displays the **Menu** screen (see [figure 18](#)).

Figure 18 Menu Screen

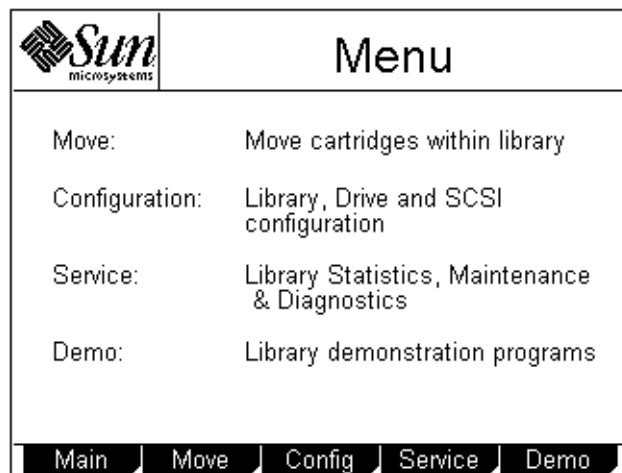

2 Press **Move**.

The GUI displays the **Move Cartridge FROM** screen (see [figure 19](#)). A flashing arrow indicates the currently selected source element.

Figure 19 Sample Move Cartridge FROM Screen

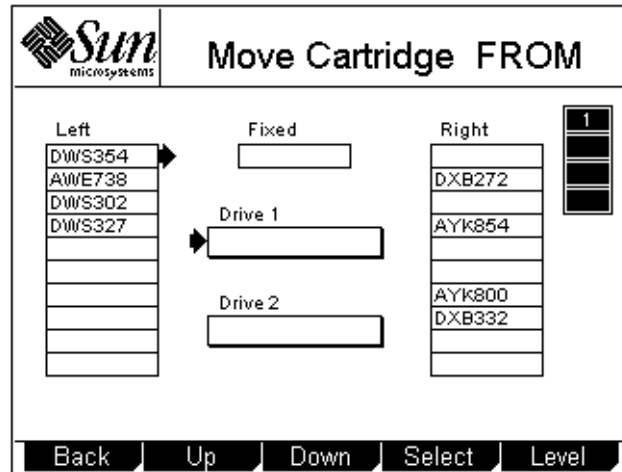

- 3 If the library is an L25 in a multiple library stack or an L100, press the **Level** button to select the level where the desired source element is located.
- 4 Press the **Up** and **Down** buttons to select the source element of the cartridge.
- 5 When the flashing arrow is next to the desired source element, press **Select**.

The GUI displays the **Move Cartridge TO** screen (see [figure 20](#)). A flashing arrow indicates the currently selected destination element.

Figure 20 Sample Move Cartridge TO Screen

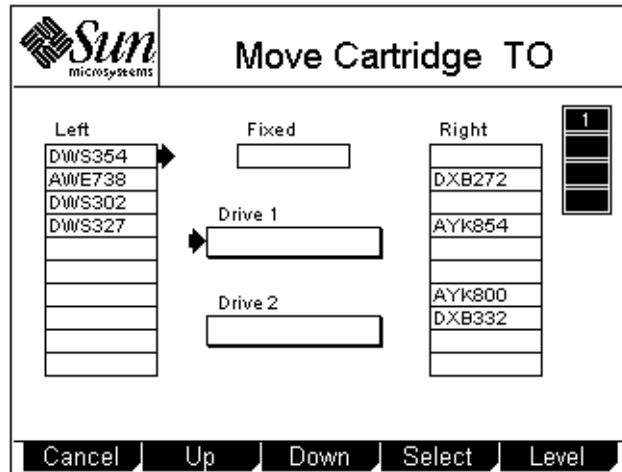

- 6 If the library is an L25 in a multiple library stack or an L100, press the **Level** button to select the level where the desired destination element is located.
- 7 Press the **Up** and **Down** buttons to select the destination element.
- 8 When the flashing arrow is next to the desired destination element, press **Select**.

The GUI displays the **Confirm Move Cartridge** screen (see [figure 21](#)).

Figure 21 Sample  
Confirm Move  
Cartridge Screen

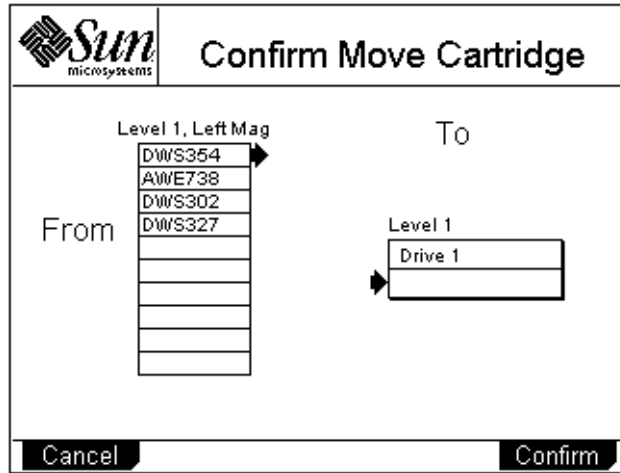

- 9 Verify that the GUI displays the correct source and destination elements, then press **Confirm**.

To cancel the cartridge move, press **Cancel**.

The GUI displays the message **Moving cartridge... Please wait**.

After the cartridge move is complete, the GUI displays the **Move Cartridge FROM** screen again.

- 10 Press **Back** to return to the **Menu** screen.
- 11 Press **Main** to return to the main screen.

---

## Using the Mailbox

Using the **Mailbox** screen, you can:

- View mailbox status
- Import and export cartridges
- Change the size of the mailbox by changing the setting of the **Import/Export** option

To access the **Mailbox** screen, press **Mailbox** on the main screen. The GUI displays the **Mailbox** screen (see [figure 22](#)).

---

Figure 22 Sample Mailbox Screen

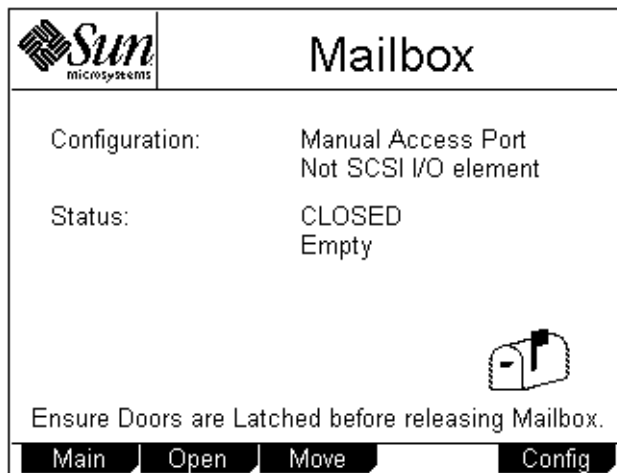

---

## Viewing Mailbox Status

The **Mailbox** screen displays the following information:

- The current setting of the **Import/Export** option (see [Changing the Import/Export Setting](#) on page 69 for more information about the available settings)
- Whether the mailbox is open or closed
- Whether the mailbox is occupied
- The bar code number of the cartridge, if the mailbox is occupied

**Note:** If the **Import/Export** option is set to `None`, the **Mailbox** screen does not display any “Status” or “Tape” information.

If the **Import/Export** option is set to `10-Slot` (or `12-Slot` for LTO), the **Mailbox** screen does not display any “Status: Occupied” or “Tape” information.

---

## Importing and Exporting Cartridges

The procedure for importing and exporting cartridges varies depending on the setting of the **Import/Export** option (see [Changing the Import/Export Setting](#) on page 69).

- To import and export cartridges when the **Import/Export** option is set to manual access port (MAP), see [Importing a Cartridge in MAP Mode](#) and [Exporting a Cartridge in MAP Mode](#).
- To import and export cartridges when the **Import/Export** option is set to `10-Slot` (or `12-Slot` in LTO libraries), see [Importing Cartridges in 10-Slot or 12-Slot Mode](#) and [Exporting Cartridges in 10-Slot or 12-Slot Mode](#).
- To import and export cartridges when the **Import/Export** option is set to `1-Slot`, see [Importing a Cartridge in 1-Slot Mode](#) and [Exporting a Cartridge in 1-Slot Mode](#).

### Importing a Cartridge in MAP Mode

To import a cartridge in MAP mode:

- 1 On the main screen, press **Mailbox**.

The GUI displays the **Mailbox** screen (see [figure 22](#)).

- 2 Press **Open**.

The GUI displays the **Mailbox - OPEN** screen (see [figure 23](#)).

Figure 23 Mailbox -  
OPEN Screen

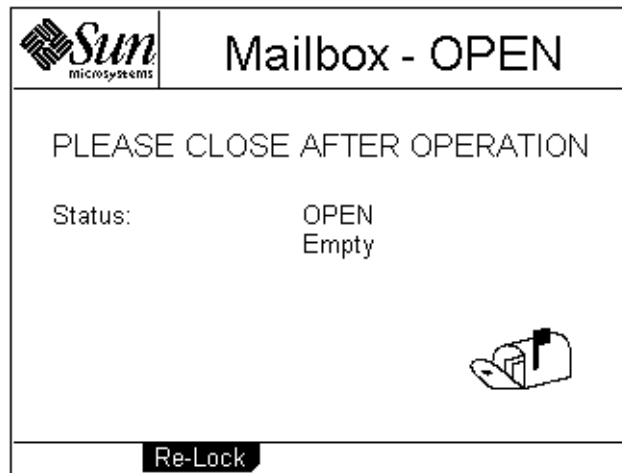

- 3 Press the white button next to the top left magazine access door and open the door.
- 4 Pull the magazine forward until it stops.
- 5 Remove the data cartridge (if any) from the mailbox.
- 6 Insert the cartridge you wish to import into the mailbox.
- 7 Reinsert the magazine into the library.
- 8 Close the magazine access door.
- 9 On the **Mailbox - OPEN** screen, press **Re-Lock**.

The library locks the magazine access door and inventories the mailbox.



- 10 Use the **Move** command on the **Mailbox** screen to move the imported cartridge to another data element.
- 11 If you removed a data cartridge from the mailbox, replace it:
  - a Repeat steps [1](#) through [4](#) to open the mailbox again.
  - b Reinsert the data cartridge you removed in [step 5](#) into the mailbox.
  - c Reinsert the magazine into the library.
  - d Close the magazine access door.
  - e On the **Mailbox** screen, press **Re-Lock**.  
The magazine access door locks.

### Exporting a Cartridge in MAP Mode

To export a cartridge in MAP mode:

- 1 If there is currently a data cartridge in the mailbox, remove it:
  - a On the main screen, press **Mailbox**.  
The GUI displays the **Mailbox** screen (see [figure 22](#)).
  - b Press **Open**.  
The GUI displays the **Mailbox - OPEN** screen (see [figure 23](#)).
  - c Press the white button next to the top left magazine access door and open the door.
  - d Pull the magazine forward until it stops.
  - e Remove the data cartridge from the mailbox.
  - f Reinsert the magazine into the library.
  - g Close the magazine access door.
  - h On the **Mailbox - OPEN** screen, press **Re-Lock**.

The library locks the magazine access door and inventories the mailbox.

- 2 Use the **Move** command on the **Mailbox** screen to move the cartridge you wish to export to the mailbox.
- 3 Repeat steps [1a](#) through [1d](#) to open the mailbox again.
- 4 Remove the exported cartridge from the mailbox.
- 5 Reinsert the data cartridge you removed in [step 1e](#) (if any) into the mailbox.
- 6 Reinsert the magazine into the library.
- 7 Close the magazine access door.
- 8 On the **Mailbox - OPEN** screen, press **Re-Lock**.  
The library locks the magazine access door and inventories the mailbox.

### Importing Cartridges in 10-Slot or 12-Slot Mode

To import cartridges in 10-slot or 12-slot mode:

- 1 On the main screen, press **Mailbox**.  
The GUI displays the **Mailbox** screen (see [figure 22](#)).
- 2 Press **Open**.  
The GUI displays the **Mailbox - OPEN** screen (see [figure 23](#)).
- 3 Press the white button next to the top left magazine access door and open the door.
- 4 Pull the magazine out of the library.
- 5 Insert the cartridges you wish to import into the magazine.
- 6 Reinsert the magazine into the library.
- 7 Close the magazine access door.
- 8 On the **Mailbox - OPEN** screen, press **Re-Lock**.  
The library locks the magazine access door and the cartridges are moved under control of the host software to the desired locations.

### Exporting Cartridges in 10-Slot or 12-Slot Mode

To export cartridges in 10-slot or 12-slot mode:

- 1 Use the backup software to export cartridges to the top left magazine.
- 2 On the main screen, press **Mailbox**.  
The GUI displays the **Mailbox** screen (see [figure 22](#)).
- 3 Press **Open**.  
The GUI displays the **Mailbox - OPEN** screen (see [figure 23](#)).
- 4 Press the white button next to the top left magazine access door and open the door.
- 5 Pull the magazine out of the library.
- 6 Remove the cartridges from the magazine.
- 7 Reinsert the magazine into the library.
- 8 Close the magazine access door.
- 9 On the **Mailbox - OPEN** screen, press **Re-Lock**.  
The library locks the magazine access door.

### Importing a Cartridge in 1-Slot Mode

To import a cartridge in 1-slot mode:

- 1 On the main screen, press **Mailbox**.  
The GUI displays the **Mailbox** screen (see [figure 22](#)).
- 2 Press **Open**.  
The GUI displays the **Mailbox - OPEN** screen (see [figure 23](#)).
- 3 Press the white button next to the top left magazine access door and open the door.
- 4 Pull the magazine forward until it stops.
- 5 Insert the cartridge you wish to import into the mailbox.

- 6 Reinsert the magazine into the library.
- 7 Close the magazine access door.
- 8 On the **Mailbox - OPEN** screen, press **Re-Lock**.

The library locks the magazine access door and the cartridge is moved under control of the host software to the desired location.

### Exporting a Cartridge in 1-Slot Mode

To export a cartridge in 1-slot mode:

- 1 Use the backup software to export cartridges to the first slot of the top left magazine.
- 2 On the main screen, press **Mailbox**.

The GUI displays the **Mailbox** screen (see [figure 22](#)).

- 3 Press **Open**.

The GUI displays the **Mailbox - OPEN** screen (see [figure 23](#)).

- 4 Press the white button next to the top left magazine access door and open the door.
- 5 Pull the magazine forward until it stops.
- 6 Remove the exported cartridge from the magazine.
- 7 Reinsert the magazine into the library.
- 8 Close the magazine access door.
- 9 On the **Mailbox - OPEN** screen, press **Re-Lock**.

The library locks the magazine access door.

## Configuring the Mailbox

By default, the **Import/Export** option is set to `MAP`. To change this setting:

- 1 On the main screen, press **Mailbox**.

The GUI displays the **Mailbox** screen (see [figure 22](#)).

- 2 On the **Mailbox** screen, press **Config**.

The GUI displays the **Configuration** screen, with the **Import/Export** option highlighted.

- 3 Use the **Up** and **Down** buttons to select the desired Import/Export setting. The available settings are `None`, `1-Slot`, `10-Slot` (or `12-Slot` in LTO libraries), and `MAP`.

**Note:** The default setting is `MAP`.

For more information about these settings, see [Changing the Import/Export Setting](#) on page 69.

- 4 Press **Select**.

- 5 Press **Main** to return to the main screen.

**Caution:** If you do not return to the main screen after changing this setting, your change will not be saved to NVRAM.

**Note:** You must reboot the library before this setting will take effect.

---

## Removing the Magazines

To remove a magazine from an L25 library, see [Removing a Magazine from an L25](#).

To remove a magazine from an L100 library, see [Removing a Magazine from an L100](#).

---

### Removing a Magazine from an L25

The method for removing the magazines differs depending on whether the L25 library is powered up or down:

- To remove a magazine from the L25 library when it is powered up, see [Removing a Magazine when the L25 Library is Powered Up](#).
- To remove a magazine from the L25 library when it is powered down, see [Removing a Magazine when the L25 Library is Powered Down](#).

### Removing a Magazine when the L25 Library is Powered Up

The magazines are locked in place during normal library operation. To remove one of these magazines, you must first release the magazine using the GUI.

To remove the left or right magazine when the L25 library is powered up:

- 1 On the main screen, press **Mags**.

The GUI displays the **Release Magazines** screen (see [figure 24](#)).

Figure 24 Sample  
Release Magazines  
Screen

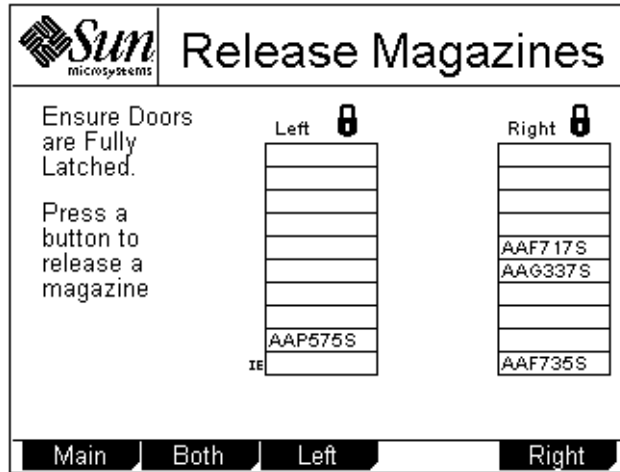

2 Press the button corresponding to the magazine you want to release:

- To release both magazines, press **Both**.
- To release the left magazine, press **Left**.
- To release the right magazine, press **Right**.

The GUI indicates that the magazine or magazines have been released.

- 3 Press the white button next to the desired magazine access door and open the door.
- 4 Grasp the handle at the front of the magazine and pull it forward and out of the library.
- 5 When you are finished adding or removing cartridges from the magazine, replace it in the library and close the magazine door.
- 6 On the **Release Magazines** screen, press **Re-Lock**.

The library locks the magazine access doors and inventories the magazines. When the inventory is complete, the GUI displays the main screen.

## Removing a Magazine when the L25 Library is Powered Down

To remove a magazine when the library is powered down:

- 1 Look through the viewing window and verify that all cartridges are fully seated either in a magazine slot or in the robotic hand.

**Caution:** You can damage the library severely if you try to remove a magazine when one of the data cartridges is not fully seated.

- 2 Press the white button next to the magazine access door.  
The magazine access door opens.
- 3 To remove the left magazine:
  - a Using a slender object such as a pen, press and hold the magazine release button (see [figure 25](#)).
  - b Grasp the handle at the front of the left magazine and slide it forward and out of the library.

Figure 25 Magazine Release Button

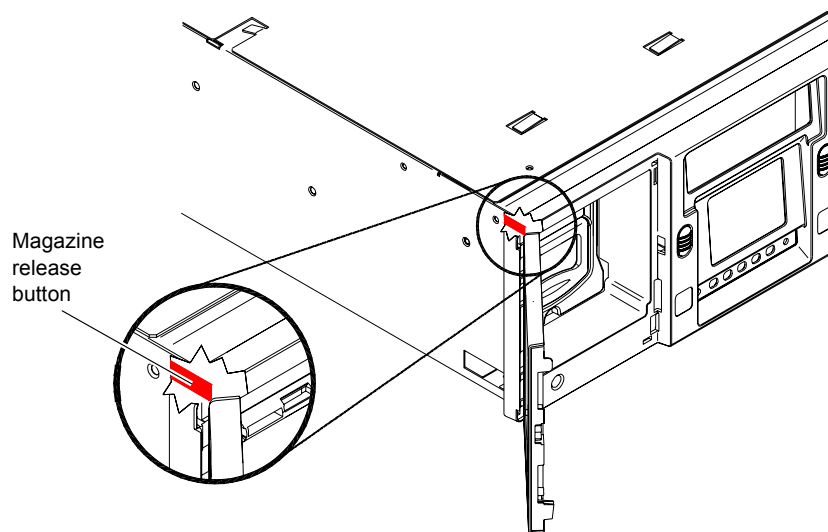



- 4 To remove the right magazine, grasp the handle at the front of the magazine and slide it forward and out of the library.

---

### Removing a Magazine from an L100

The method for removing the magazines differs depending on whether the L100 library is powered up or down:

- To remove a magazine from the L100 library when it is powered up, see [Removing a Magazine when the L100 Library is Powered Up](#).
- To remove a magazine from the L100 library when it is powered down, see [Removing a Magazine when the L100 Library is Powered Down](#).

### Removing a Magazine when the L100 Library is Powered Up

The magazines are locked in place during normal library operation. To remove one of these magazines, you must first release the magazine using the GUI.

To remove a magazine when the library is powered up:

- 1 On the main screen, press **Mags**.

The GUI displays the **Release Magazines** screen (see [figure 26](#)).

---

Figure 26 Release Magazines Screen

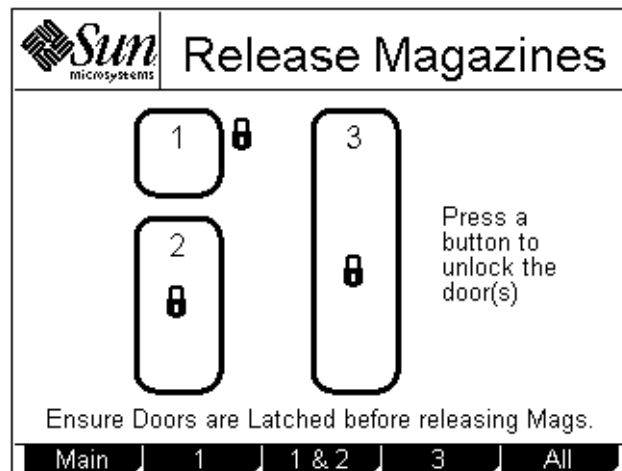

- 2 Press the button corresponding to the magazine access door you want to open:
  - To release the top left magazine access door, press **1**.
  - To release both left magazine access doors, press **1 & 2**.
  - To release the right magazine access door, press **3**.
  - To release all the magazine access doors, press **All**.
- 3 Press the white button next to the desired magazine access door and open the door.

**Note:** If you are opening the bottom left magazine access door, open the top left magazine access door first.

- 4 Grasp the handle at the front of the desired magazine and pull it forward and out of the library.
- 5 When you are finished adding or removing cartridges from the magazine, replace it in the library and close the magazine access door.
- 6 On the **Release Magazines** screen, press **Re-Lock**.

The library locks the magazine access doors and inventories the magazines. When the inventory is complete, the GUI displays the main screen.

### Removing a Magazine when the L100 Library is Powered Down

To remove a magazine when the library is powered down:

- 1 Look through the viewing window and verify that all cartridges are fully seated either in a magazine slot or in the robotic hand.

**Caution:** You can damage the library severely if you try to remove a magazine when one of the data cartridges is not fully seated.

- 2 To remove the level 1 left magazine:
  - a Press the white button next to the top left magazine access door and open the door.
  - b Grasp the handle at the front of the level 1 left magazine and pull it forward until it stops.

**Note:** Depending on the setting of the **Import/Export** option, you may only be able to pull out the top left magazine far enough to access the first magazine slot.

- c If the magazine stops after the first slot, perform steps [2d](#) through [2h](#) to remove it.
- d Press the white button next to the bottom left magazine access door and open the door.
- e Remove the level 2 left magazine (see [figure 27](#)).

Figure 27 Removing the Level 2 Left Magazine

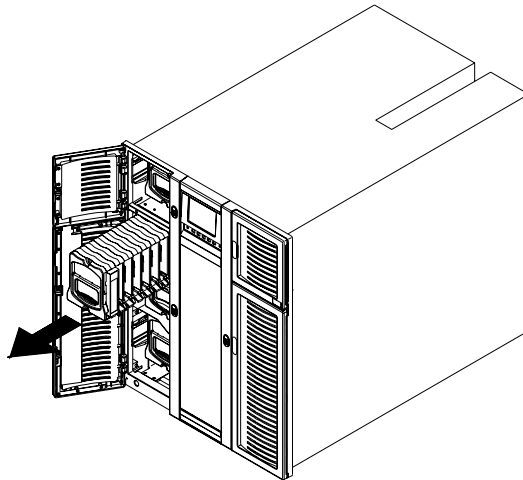

- f Reach into the library underneath the level 1 left magazine and press up on the release latch (see [figure 28](#)).

Figure 28 Pressing the Release Latch

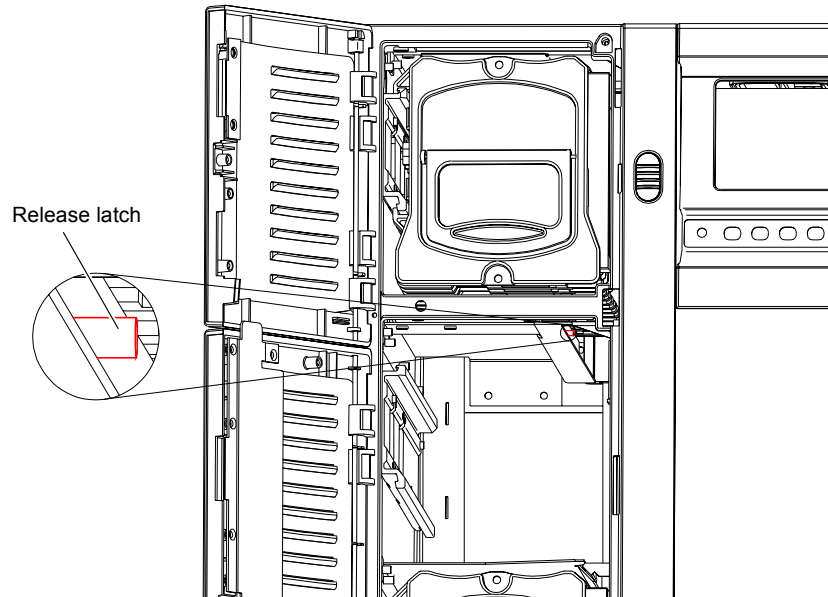

- g While holding the release latch, pull the level 1 left magazine forward and out of the library (see [figure 29](#)).

Figure 29 Removing the Level 1 Left Magazine

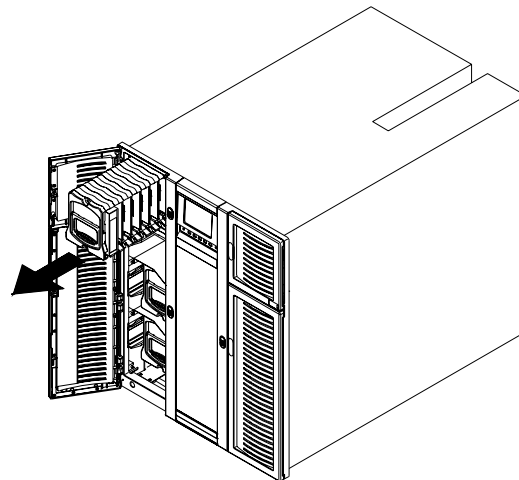

- h Reinsert the level 2 left magazine into the library and close the bottom left magazine access door.
- 3 To remove any other magazine:
  - a Press the white button next to the desired magazine access door.

**Note:** If you are opening the bottom left magazine access door, open the top left magazine access door first.

The magazine access door opens.

- b Grasp the handle at the front of the desired magazine and slide it forward and out of the library.

---

## Viewing Statistics

This section explains how to view library, drive, and SCSI statistics using the **Statistics Menu** screen.

---

### Accessing the Statistics Menu Screen

To access the **Statistics Menu** screen:

- 1 On the main screen, press **Menu**.

The GUI displays the **Menu** screen.

- 2 Press **Service**.

The GUI displays the **Service Menu** screen (see [figure 30](#)).

Figure 30 Service  
Menu Screen

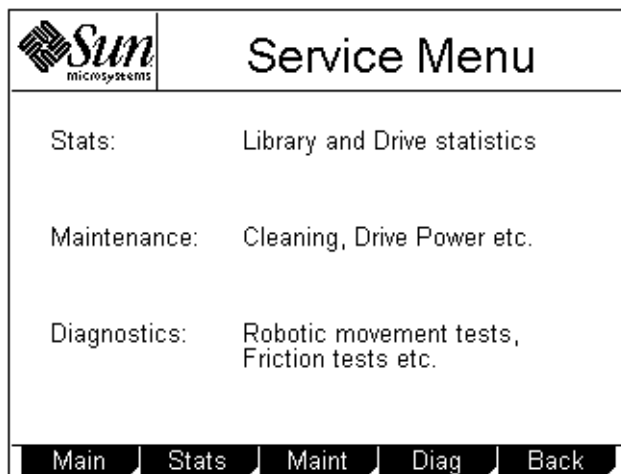

**3 Press Stats.**

The GUI displays the **Statistics Menu** screen (see [figure 31](#)).

Figure 31 Statistics  
Menu Screen

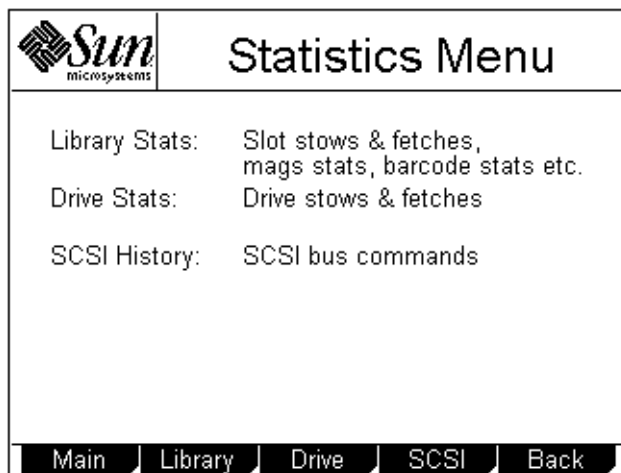

## Viewing Library Statistics

To view library statistics:

- 1 Access the **Statistics Menu** screen (see [Accessing the Statistics Menu Screen](#)).
- 2 On the **Statistics Menu** screen, press **Library**.

The GUI displays the **Library Statistics** screen (see [figure 32](#)).

Figure 32 Sample Library Statistics Screen

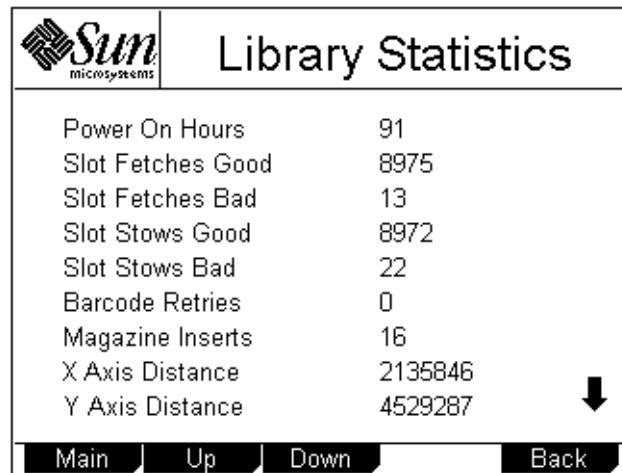

Sun microsystems		Library Statistics	
Power On Hours	91		
Slot Fetches Good	8975		
Slot Fetches Bad	13		
Slot Stows Good	8972		
Slot Stows Bad	22		
Barcode Retries	0		
Magazine Inserts	16		
X Axis Distance	2135846		
Y Axis Distance	4529287	↓	

Main Up Down Back

This screen lists the following library statistics:

- Power On Hours
- Slot Fetches Good
- Slot Fetches Bad
- Slot Stows Good
- Slot Stows Bad
- Barcode Retries
- Magazine Inserts
- X Axis Distance
- Y Axis Distance
- Z Axis Distance

- Theta Distance
  - Picker Distance
  - Elevator Distance
- 3 Press the **Up** and **Down** buttons to scroll through the list.
  - 4 When you have finished viewing the library statistics, press **Back** to return to the **Statistics Menu** screen, or press **Main** to return to the main screen.

---

### Viewing Drive Statistics

To view drive statistics:

- 1 Access the **Statistics Menu** screen (see [Accessing the Statistics Menu Screen](#)).
- 2 On the **Statistics Menu** screen, press **Drive**.

The GUI displays the **Drive Statistics** screen (see [figure 33](#)).

---

Figure 33 Sample Drive Statistics Screen

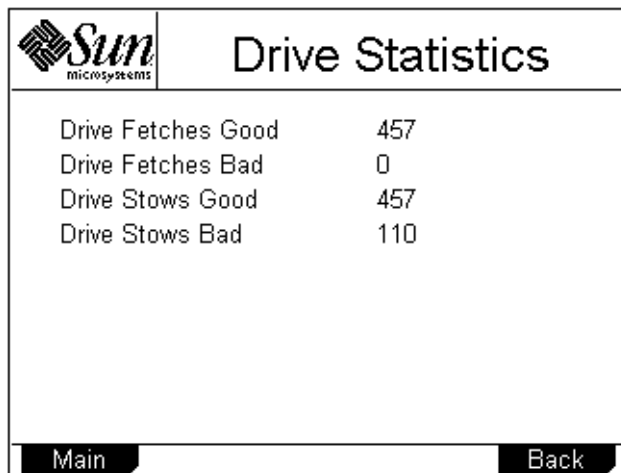

Sun microsystems		Drive Statistics	
Drive Fetches Good	457		
Drive Fetches Bad	0		
Drive Stows Good	457		
Drive Stows Bad	110		

Main Back



This screen lists the following drive statistics:

- Drive Fetches Good
- Drive Fetches Bad
- Drive Stows Good
- Drive Stows Bad

3 When you have finished viewing the drive statistics, press **Back** to return to the **Statistics Menu** screen, or press **Main** to return to the main screen.

### Viewing the SCSI History

To view a list of the SCSI commands run on the library:

- 1 Access the **Statistics Menu** screen (see [Accessing the Statistics Menu Screen](#)).
- 2 On the **Statistics Menu** screen, press **SCSI**.

The GUI displays the **SCSI History** screen (see [figure 34](#)).

Figure 34 Sample SCSI History Screen

Sun microsystems		SCSI History	
5-Mar-2002 8:45	Move Medium	OK	
5-Mar-2002 8:46	Move Medium	OK	
5-Mar-2002 8:46	Move Medium	OK	
5-Mar-2002 8:46	Move Medium	OK	
5-Mar-2002 8:46	Move Medium	OK	
5-Mar-2002 8:46	Move Medium	OK	
5-Mar-2002 8:46	Move Medium	OK	
5-Mar-2002 8:46	Move Medium	OK	
5-Mar-2002 8:46	Move Medium	OK	
5-Mar-2002 8:47	Move Medium	OK	
5-Mar-2002 8:48	Log Sense	05-24-00	↓
5-Mar-2002 8:48	Request Sense	OK	
5-Mar-2002 8:52	Inquiry	OK	
Main		Up	Down
		Back	

This screen lists SCSI commands by date and time.

- 3 Press the **Up** and **Down** buttons to scroll through the list.
- 4 When you have finished viewing the SCSI history, press **Back** to return to the **Statistics Menu** screen, or press **Main** to return to the main screen.

---

## Viewing the Stack Configuration

If the library module is part of a multiple library stack, you can view the configuration of the entire stack using the **Stack Configuration** screen.

To access the **Stack Configuration** screen:

- On an L25 library, press **Stack** on the main screen.
- On an L100 library, press **Level** on the main screen until the **Stack** button appears at the lower right corner of the screen. Press **Stack**.

The GUI displays the **Stack Configuration** screen (see [figure 35](#)).

Figure 35 Sample Stack Configuration Screen

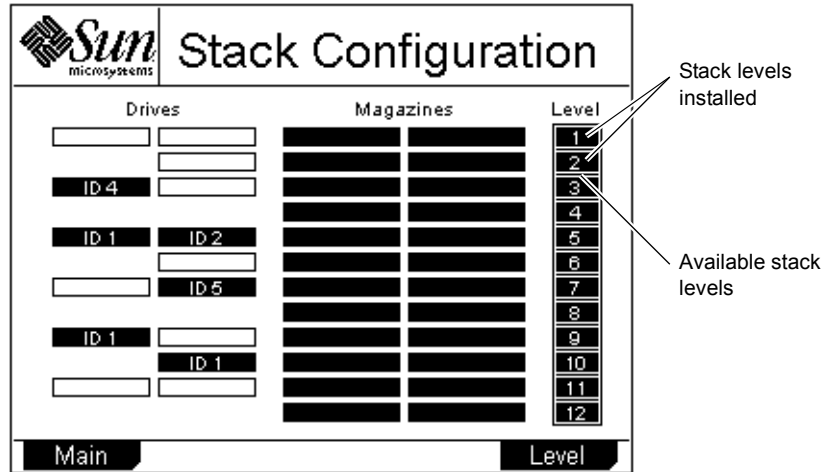

- ID 1 = Drive installed
- = Drive not installed
- Disabled = Drive disabled
- = Magazine installed
- = Magazine not installed

This screen displays the:

- Maximum size of the library (this depends on the length of the StackLink installed)
- Number of library modules installed in the stack
- Number, location, and SCSI IDs of the tape drives installed
- Number and location of the tape cartridge magazines installed

When you are finished viewing the **Stack Configuration** screen, press **Main** to return to the main screen.



## Chapter 3

# Changing the Library Configuration

---

This chapter explains how to change the library configuration using the GUI **Configuration** screen.

---

## Accessing the Configuration Screen

To access the **Configuration** screen:

- 1 On the main screen, press **Menu**.

The GUI displays the **Menu** screen (see [figure 36](#)).

Figure 36 Menu  
Screen

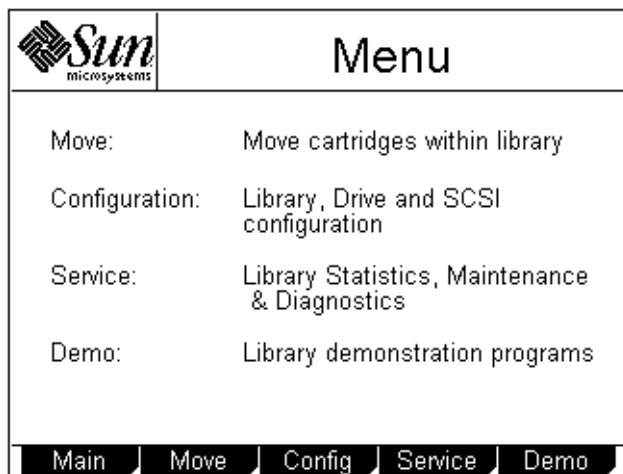

2 Press **Config**.

The GUI displays the **Configuration** screen (see [figure 37](#)).

Figure 37  
Configuration Screen

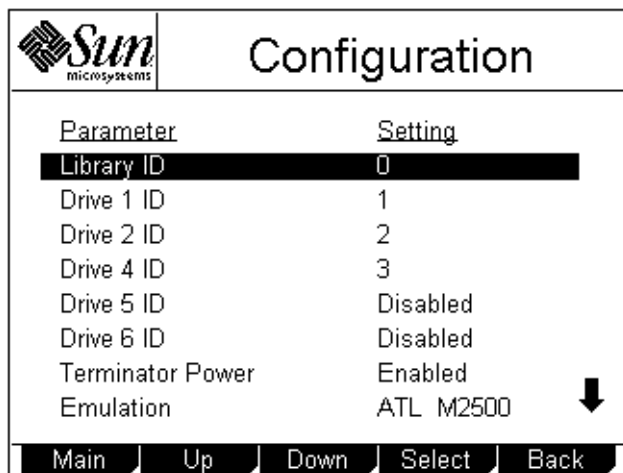

---

## Setting the Library ID

By default the library SCSI ID is set to 0. To change the library SCSI ID setting:

- 1 Access the **Configuration** screen (see [Accessing the Configuration Screen](#)).
- 2 Press the **Up** or **Down** buttons until **Library ID** is highlighted.
- 3 Press **Select**.
- 4 Use the **Up** or **Down** buttons to select the desired SCSI ID. Available settings are 0 through 15.
- 5 Press **Select**.

To return to the **Configuration** screen without changing the option setting, press **Cancel**.

- 6 Press **Main** to return to the main screen.

**Caution:** If you do not return to the main screen after changing this setting, your change will not be saved to NVRAM.

**Note:** You must reboot the library before this setting will take effect.

## Changing a Tape Drive ID

By default, the L25 tape drive SCSI IDs are set as follows:

- Drive 1 ID = 1
- Drive 2 ID = 2

The L100 tape drive SCSI IDs are set as follows:

- Drive 1 ID = 1
- Drive 2 ID = 2
- Drive 3 ID = 3
- Drive 4 ID = 4
- Drive 5 ID = 15
- Drive 6 ID = 14

[Figure 38](#) illustrates the drive numbering scheme for the L100.

Figure 38 L100 Drive  
Numbering

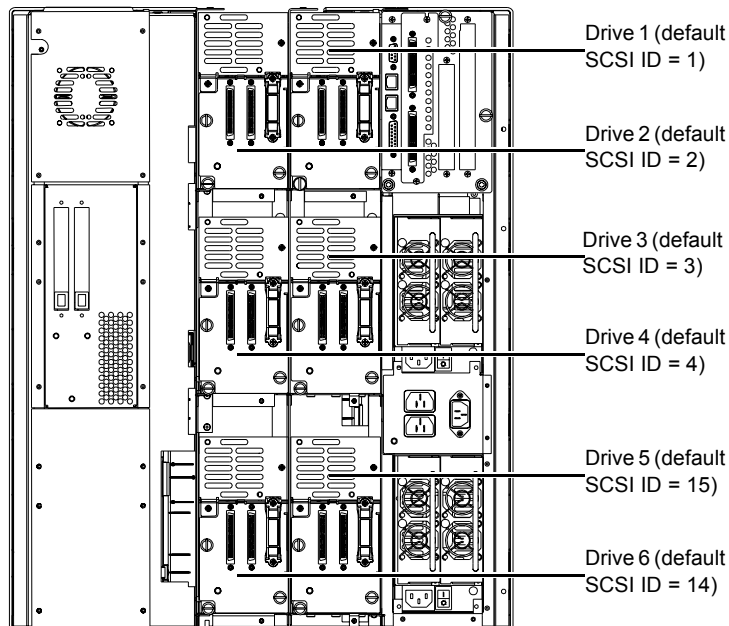



To change a tape drive SCSI ID:

- 1 Access the **Configuration** screen (see [Accessing the Configuration Screen](#)).
- 2 Press the **Up** or **Down** buttons until the desired drive ID (for example, **Drive 1 ID**) is highlighted.
- 3 Press **Select**.
- 4 Use the **Up** or **Down** buttons to select the desired SCSI ID. Available settings are 0 through 9, A through F, and Disabled.

**Caution:** Set the drive SCSI ID to `Disabled` only if the drive is not installed in the library.

- 5 Press **Select**.

To return to the **Configuration** screen without changing the option setting, press **Cancel**.

- 6 If desired, repeat steps [2](#) through [5](#) to set the SCSI ID for another tape drive.
- 7 Press **Main** to return to the main screen.

**Caution:** If you do not return to the main screen after changing this setting, your change will not be saved to NVRAM.

**Note:** You must reboot the library before this setting will take effect.

---

## Changing the Terminator Power Setting

The **Terminator Power** option controls whether the library robotics provide terminator power.

To enable or disable robotics terminator power:

- 1 Access the **Configuration** screen (see [Accessing the Configuration Screen](#)).
- 2 Press the **Up** or **Down** buttons until **Terminator Power** is highlighted.
- 3 Press **Select**.
- 4 Use the **Up** or **Down** buttons to select the desired **Terminator Power** setting. Available settings are `Enabled` and `Disabled`.

**Note:** The default setting is `Enabled`.

- 5 Press **Select**.

To return to the **Configuration** screen without changing the option setting, press **Cancel**.

- 6 Press **Main** to return to the main screen.

**Caution:** If you do not return to the main screen after changing this setting, your change will not be saved to NVRAM.

**Note:** You must reboot the library before this setting will take effect.

---

## Changing the Emulation Setting

The **Emulation** option allows you to set the library to act as either a Quantum ATL library or an M4 Data library.

To set the emulation:

- 1 Access the **Configuration** screen (see [Accessing the Configuration Screen](#) on page 53).
- 2 Press the **Up** or **Down** buttons until **Emulation** is highlighted.
- 3 Press **Select**.
- 4 Use the **Up** or **Down** buttons to select the desired **Emulation** setting. The available settings are ATL M2500, ATL 1500, and M4 Data.

**Note:** The default setting for the L25 is M4 Data; the default setting for the L100 is ATL M2500.

- 5 Press **Select**.

To return to the **Configuration** screen without changing the option setting, press **Cancel**.

- 6 Press **Main** to return to the main screen.

**Caution:** If you do not return to the main screen after changing this setting, your change will not be saved to NVRAM.

**Note:** You must reboot the library before this setting will take effect.

---

## Changing the Sync Negotiation Setting

The **Sync Negotiation** option controls whether the library robotics negotiates synchronous data transfer mode. Normally, this negotiation is performed by the host.

**Note:** This option does not enable or disable synchronous data transfers; it only controls the ability of the library to negotiate for such transfers.

To enable or disable **Sync Negotiation**:

- 1 Access the **Configuration** screen (see [Accessing the Configuration Screen](#) on page 53).
- 2 Press the **Up** or **Down** buttons until **Sync Negotiation** is highlighted.
- 3 Press **Select**.
- 4 Use the **Up** or **Down** buttons to select the desired **Sync Negotiation** setting. The available settings are *Enabled* and *Disabled*.

**Note:** The default setting is *Enabled*.

- 5 Press **Select**.

To return to the **Configuration** screen without changing the option setting, press **Cancel**.

- 6 Press **Main** to return to the main screen.

**Caution:** If you do not return to the main screen after changing this setting, your change will not be saved to NVRAM.

---

## Changing the Wide Negotiation Setting

The **Wide Negotiation** option controls whether the library robotics negotiates wide data transfer mode. Normally, this negotiation is performed by the host.

**Note:** This option does not enable or disable wide data transfers; it only controls the ability of the library to negotiate for such transfers.

To enable or disable **Wide Negotiation**:

- 1 Access the **Configuration** screen (see [Accessing the Configuration Screen](#) on page 53).
- 2 Press the **Up** or **Down** buttons until **Wide Negotiation** is highlighted.
- 3 Press **Select**.
- 4 Use the **Up** or **Down** buttons to select the desired **Wide Negotiation** setting. The available settings are **Enabled** and **Disabled**.

**Note:** The default setting is **Enabled**.

- 5 Press **Select**.

To return to the **Configuration** screen without changing the option setting, press **Cancel**.

- 6 Press **Main** to return to the main screen.

**Caution:** If you do not return to the main screen after changing this setting, your change will not be saved to NVRAM.

---

## Changing the Serialization Setting

The **Serialization** option controls how the library returns the tape drive serial number when a `Read Element Status` is requested.

When **Serialization** is set to `On`, the tape drive serial number is returned in a format compatible with Quantum ATL Prism products. When **Serialization** is set to `Off`, the tape drive serial number is returned in a vendor unique format. This setting is only valid when **Emulation** is set to `ATL M2500` or `ATL 1500` (see [Changing the Emulation Setting](#) on page 59).

To enable or disable drive serialization:

- 1 Access the **Configuration** screen (see [Accessing the Configuration Screen](#) on page 53).
- 2 Press the **Up** or **Down** buttons until **Serialization** is highlighted.
- 3 Press **Select**.
- 4 Use the **Up** or **Down** buttons to select the desired **Serialization** setting. The available settings are `Enabled` and `Disabled`.

**Note:** The default setting is `Disabled`.

- 5 Press **Select**.

To return to the **Configuration** screen without changing the option setting, press **Cancel**.

- 6 Press **Main** to return to the main screen.

**Caution:** If you do not return to the main screen after changing this setting, your change will not be saved to NVRAM.

---

## Changing the Short Labels Setting

The **Short Labels** option controls how many bar code label characters are returned when the host issues a Read Element Status command. When **Short Labels** is set to:

- *Off*, all of the bar code label characters are returned
- *On*, only the first six characters of the bar code label are returned

To enable or disable **Short Labels**:

- 1 Access the **Configuration** screen (see [Accessing the Configuration Screen](#) on page 53).
- 2 Press the **Up** or **Down** buttons until **Short Labels** is highlighted.
- 3 Press **Select**.
- 4 Use the **Up** or **Down** buttons to select the desired **Short Labels** setting. The available settings are *Enabled* and *Disabled*.

**Note:** The default setting is *Disabled*.

- 5 Press **Select**.
- 6 To return to the **Configuration** screen without changing the option setting, press **Cancel**.
- 7 Press **Main** to return to the main screen.

**Caution:** If you do not return to the main screen after changing this setting, your change will not be saved to NVRAM.

---

## Changing the Illumination Setting

The **Illumination** option allows you to turn the interior illumination of the library on or off. This illumination allows you to view the robotics easily through the viewing window.

To enable or disable **Illumination**:

- 1 Access the **Configuration** screen (see [Accessing the Configuration Screen](#) on page 53).
- 2 Press the **Up** or **Down** buttons until **Illumination** is highlighted.
- 3 Press **Select**.
- 4 Use the **Up** or **Down** buttons to select the desired **Illumination** setting. The available settings are **Enabled** and **Disabled**.

**Note:** The default setting is **Enabled**.

- 5 Press **Select**.

To return to the **Configuration** screen without changing the option setting, press **Cancel**.

- 6 Press **Main** to return to the main screen.

**Caution:** If you do not return to the main screen after changing this setting, your change will not be saved to NVRAM.



---

## Changing the Off-Line Time Setting

When you access the **Menu** screen using the GUI, the library becomes NOT READY and will not respond to any SCSI commands issued. If you leave the library unattended in menu mode, the library goes back to a READY state after a pre-set time-out, controlled by the **Off-Line Time** option. You can set this time-out to any value from 1 to 99 minutes, or turn it off.

To set the **Off-Line Time**:

- 1 Access the **Configuration** screen (see [Accessing the Configuration Screen](#) on page 53).
- 2 Press the **Up** or **Down** buttons until **Off-Line Time** is highlighted.
- 3 Press **Select**.
- 4 Use the **Up** or **Down** buttons to select the desired **Off-Line Time** setting. The available settings are 1 through 99 and Disabled.

**Note:** The default setting is Disabled.

- 5 Press **Select**.

To return to the **Configuration** screen without changing the option setting, press **Cancel**.

- 6 Press **Main** to return to the main screen.

**Caution:** If you do not return to the main screen after changing this setting, your change will not be saved to NVRAM.

---

## Changing the Barcode Scanner Setting

The **Barcode Scanner** option controls whether the bar code scanner is enabled or disabled. When the scanner is enabled, the library attempts to detect a bar code on all tape cartridge labels. If the correct bar code labels are not used, or if some cartridges are not labeled, scanning time may be greatly increased. Therefore, it is recommended that you disable the **Barcode Scanner** option if you do not intend to use compatible bar code labels.

To enable or disable the **Barcode Scanner** option:

- 1 Access the **Configuration** screen (see [Accessing the Configuration Screen](#) on page 53).
- 2 Press the **Up** or **Down** buttons until **Barcode Scanner** is highlighted.
- 3 Press **Select**.
- 4 Use the **Up** or **Down** buttons to select the desired **Barcode Scanner** setting. The available settings are **Enabled** and **Disabled**.

**Note:** The default setting is **Enabled**.

- 5 Press **Select**.

To return to the **Configuration** screen without changing the option setting, press **Cancel**.

- 6 Press **Main** to return to the main screen.

**Caution:** If you do not return to the main screen after changing this setting, your change will not be saved to NVRAM.

**Note:** You must reboot the library before this setting will take effect.

---

## Changing the Baud Rate Setting

The **Baud Rate** option controls the baud rate setting of the serial diagnostics port. You can set the baud rate to any standard rate between 1200 baud and 38400 baud.

To set the **Baud Rate**:

- 1 Access the **Configuration** screen (see [Accessing the Configuration Screen](#) on page 53).
- 2 Press the **Up** or **Down** buttons until **Baud Rate** is highlighted.
- 3 Press **Select**.
- 4 Use the **Up** or **Down** buttons to select the desired **Baud Rate** setting. The available settings are 38400, 19200, 9600, 4800, 2400, and 1200.
- 5 Press **Select**.

To return to the **Configuration** screen without changing the option setting, press **Cancel**.

- 6 Press **Main** to return to the main screen.

**Caution:** If you do not return to the main screen after changing this setting, your change will not be saved to NVRAM.

---

## Setting the Time

To set the time:

- 1 Access the **Configuration** screen (see [Accessing the Configuration Screen](#) on page 53).
- 2 Press the **Up** or **Down** buttons until **Time** is highlighted.
- 3 Press **Select**.

The hour setting is highlighted.

- 4 Use the **Up** or **Down** buttons to select the correct hour setting.
- 5 Press **Select**.

The minute setting is highlighted.

- 6 Use the **Up** or **Down** buttons to select the correct minute setting.
- 7 Press **Select**.

The seconds setting is highlighted.

- 8 Use the **Up** or **Down** buttons to select the correct seconds setting.
- 9 Press **Select**.
- 10 Press **Main** to return to the main screen.

**Caution:** If you do not return to the main screen after changing this setting, your change will not be saved to NVRAM.

---

## Setting the Date

To set the date:

- 1 Access the **Configuration** screen (see [Accessing the Configuration Screen](#) on page 53).
- 2 Press the **Up** or **Down** buttons until **Date** is highlighted.
- 3 Press **Select**.

The day setting is highlighted.

- 4 Use the **Up** or **Down** buttons to select the correct day of the month.
- 5 Press **Select**.

The month setting is highlighted.

- 6 Use the **Up** or **Down** buttons to select the correct month.
- 7 Press **Select**.  
The year setting is highlighted.
- 8 Use the **Up** or **Down** buttons to select the correct year.
- 9 Press **Select**.
- 10 Press **Main** to return to the main screen.

**Caution:** If you do not return to the main screen after changing this setting, your change will not be saved to NVRAM.

---

## Changing the Import/Export Setting

The **Import/Export** option controls whether the host recognizes the slots of the top left magazine as import/export elements or as storage elements:

- Import/export elements are used to move cartridges in and out of the library under host control. Because these elements are used exclusively for importing and exporting cartridges, they are left empty during normal library operation, reducing the storage capacity of the library.
- Storage elements are used to store data cartridges. Using storage elements to import and export cartridges can be risky since these operations are not controlled by the host.

[Table 5](#) describes each of the possible settings for the **Import/Export** option.

Table 5 Import/Export Settings

Import/Export Setting	Description
MAP	<p>When manual access port (MAP) is selected, you can use the first slot in the top left magazine to import and export cartridges from the library. The host views the MAP as a storage element; therefore, after using the MAP to import a cartridge, you must replace the data cartridge that was originally stored there.</p> <p>For information about importing and exporting cartridges when MAP is selected, see <a href="#">Importing a Cartridge in MAP Mode</a> on page 32 and <a href="#">Exporting a Cartridge in MAP Mode</a> on page 33.</p>
10-Slot (or 12-Slot in LTO libraries)	<p>When this setting is selected, all slots in the top left magazine are configured as import/export elements. They cannot be used for storage.</p> <p>For more information about importing and exporting cartridges when 10-Slot (or 12-Slot) is selected, see <a href="#">Importing Cartridges in 10-Slot or 12-Slot Mode</a> on page 34 and <a href="#">Exporting Cartridges in 10-Slot or 12-Slot Mode</a> on page 35.</p>
1-Slot	<p>When this setting is selected, the first slot in the top left magazine is configured as an import/export element. It cannot be used for storage.</p> <p>For more information about importing and exporting cartridges when 1-Slot is selected, see <a href="#">Importing a Cartridge in 1-Slot Mode</a> on page 35 and <a href="#">Exporting a Cartridge in 1-Slot Mode</a> on page 36.</p>
None	<p>When this setting is selected, the top left magazine is used as a 10- or 12-cartridge storage element and behaves in exactly the same way as the other magazines.</p>

To select the **Import/Export** setting:

**Caution:** Changing this setting may cause the host(s) to fail to recognize the library. If you change this setting, be aware that you will have to reconfigure your backup software for the new library configuration.

- 1 Access the **Configuration** screen (see [Accessing the Configuration Screen](#) on page 53).
- 2 Press the **Up** or **Down** buttons until **Import/Export** is highlighted.
- 3 Press **Select**.
- 4 Use the **Up** or **Down** buttons to select the desired **Import/Export** setting. The available settings are None, 1-Slot, 10-Slot (or 12-Slot in LTO libraries), and MAP.

**Note:** The default setting is MAP.

- 5 Press **Select**.

To return to the **Configuration** screen without changing the option setting, press **Cancel**.

- 6 Press **Main** to return to the main screen.

**Caution:** If you do not return to the main screen after changing this setting, your change will not be saved to NVRAM.

**Note:** You must reboot the library before this setting will take effect.

---

## Changing the Auto-Clean Setting

To enable or disable **Auto-Clean**:

- 1 Access the **Configuration** screen (see [Accessing the Configuration Screen](#) on page 53).
- 2 Press the **Up** or **Down** buttons until **Auto-Clean** is highlighted.
- 3 Press **Select**.
- 4 Use the **Up** or **Down** buttons to select the desired **Auto-Clean** setting. The available settings are `Enabled` or `Disabled`.

**Note:** The default setting is `Disabled`.

- 5 Press **Select**.

To return to the **Configuration** screen without changing the option setting, press **Cancel**.

- 6 Press **Main** to return to the main screen.

**Caution:** If you do not return to the main screen after changing this setting, your change will not be saved to NVRAM.

**Note:** You must reboot the library before this setting will take effect.



---

## Changing the Ignore Host Lock Setting

The **Ignore Host Lock** option controls whether the library can release the mailbox when the host has issued a SCSI command to lock the media:

- Enabling this option allows you to release the mailbox even when the host has issued a SCSI command to lock the media.
- Disabling this option causes the library to display an error message when you try to release the mailbox when the host has locked the media.

To change the **Ignore Host Lock** setting:

- 1 Access the **Configuration** screen (see [Accessing the Configuration Screen](#) on page 53).
- 2 Press the **Up** or **Down** buttons until **Ignore Host Lock** is highlighted.
- 3 Press **Select**.
- 4 Use the **Up** or **Down** buttons to select the desired **Ignore Host Lock** setting. The available settings are *Enabled* or *Disabled*.

**Note:** The default setting is *Disabled*.

- 5 Press **Select**.

To return to the **Configuration** screen without changing the option setting, press **Cancel**.

- 6 Press **Main** to return to the main screen.

**Caution:** If you do not return to the main screen after changing this setting, your change will not be saved to NVRAM.

**Note:** You must reboot the library before this setting will take effect.

---

## Changing the Auto-Import Option

The **Auto-Import** option controls how cartridges are moved from the import/export slots of the mailbox to the magazine slots:

- Enabling this option causes the library to move any cartridges in the import/export slots to the first (lowest element address) free magazine slots automatically. The move is performed automatically (without need for host commands) at both power-up and whenever the import/export magazine is inserted.
- Disabling this option removes the above capability; the host software must issue SCSI commands to move cartridges from the import/export slots to the required magazine slots.

To change the **Auto-Import** setting:

- 1 Access the **Configuration** screen (see [Accessing the Configuration Screen](#) on page 53).
- 2 Press the **Up** or **Down** buttons until **Auto-Import** is highlighted.
- 3 Press **Select**.
- 4 Use the **Up** or **Down** buttons to select the desired **Auto-Import** setting. The available settings are `Enabled` or `Disabled`.

**Note:** The default setting is `Disabled`.

**5** Press **Select**.

To return to the **Configuration** screen without changing the option setting, press **Cancel**.

**6** Press **Main** to return to the main screen.

**Caution:** If you do not return to the main screen after changing this setting, your change will not be saved to NVRAM.

**Note:** You must reboot the library before this setting will take effect.

## Chapter 3 Changing the Library Configuration

### Changing the Auto-Import Option

## Chapter 4

# Performing Maintenance Operations

---

This chapter explains how to perform library maintenance operations using the **Maintenance** screen.

---

## Accessing the Maintenance Screen

To access the **Maintenance** screen:

- 1 On the main screen, press **Menu**.

The GUI displays the **Menu** screen.

- 2 Press **Service**.

The GUI displays the **Service Menu** screen (see [figure 39](#)).

Figure 39 Service Menu Screen

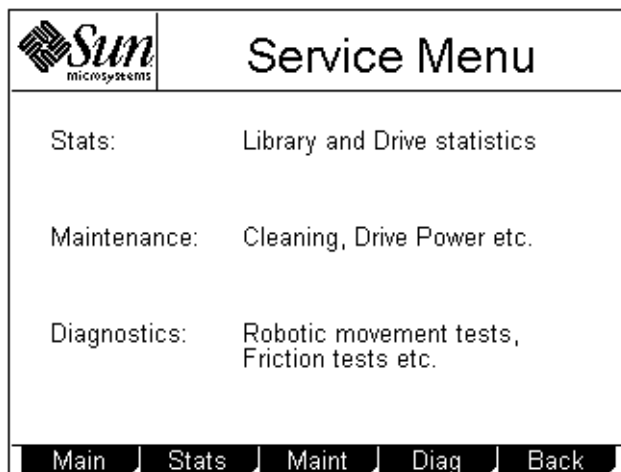

**3 Press Maint.**

The GUI displays the **Maintenance** screen (see [figure 40](#)).

Figure 40 Maintenance Screen

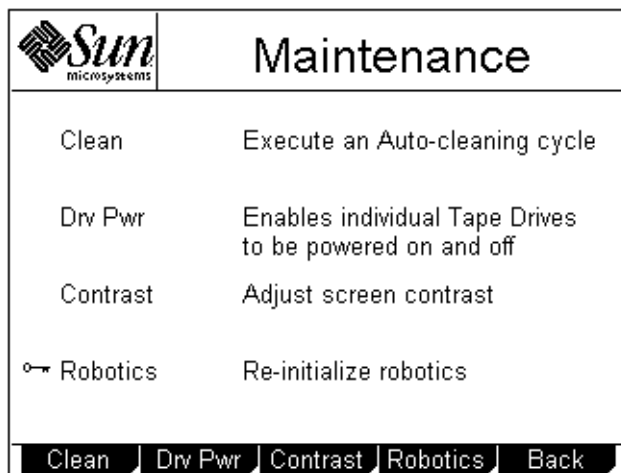

## Cleaning a Tape Drive

To clean a tape drive:

- 1 Access the **Maintenance** screen (see [Accessing the Maintenance Screen](#)).
- 2 Press **Clean**.

The GUI displays the **Select Cleaning Cartridge** screen (see [figure 41](#)). A flashing arrow indicates the currently selected source element.

Figure 41 Select Cleaning Cartridge Screen

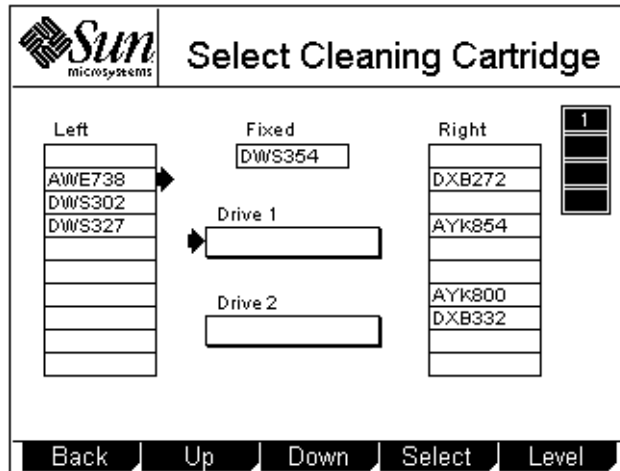

- 3 If the library is an L25 in a multiple library stack or an L100, press the **Level** button to select the level where the cleaning cartridge is located.
- 4 Press the **Up** and **Down** buttons to select the source element that contains the cleaning cartridge.
- 5 When the flashing arrow is next to the source element that contains the cleaning cartridge, press **Select**.

The GUI displays the **Select Tape Drive** screen (see [figure 42](#)). A flashing arrow indicates the currently selected drive.

Figure 42 Select Tape Drive Screen

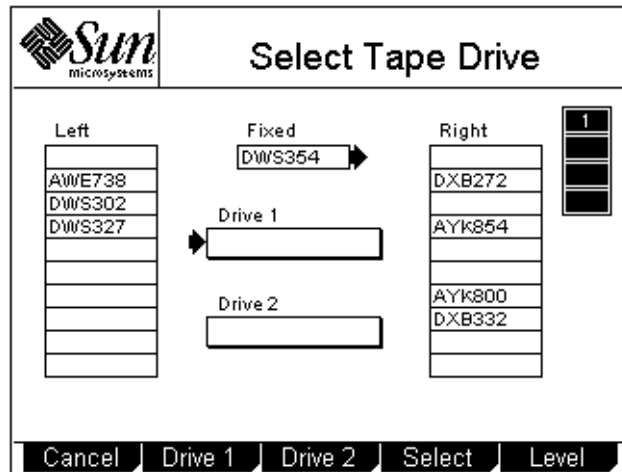

6 If the library is an L25 in a multiple library stack or an L100, press the **Level** button to select the level where the drive that requires cleaning is located.

7 Press **Drive 1** or **Drive 2**.

To cancel the operation, press **Cancel**.

8 Press **Select**.

The GUI displays the message **Cleaning in progress**. When the cleaning is done, the GUI displays the **Select Cleaning Cartridge** screen again.

9 Press Back to return to the **Maintenance** screen.



## Turning Drive Power On or Off (Maintenance Screen)

The **Drive Power** option allows you to turn drive power on or off from the GUI. Use this option to turn off drive power when you are hot-swapping a tape drive.

**Note:** This option is available on both the **Maintenance** screen and the **Quick View Menu** screen. To access this option on the **Quick View Menu** screen, refer to [Turning Drive Power On or Off \(Quick View Menu Screen\)](#) on page 24.

### Turning Drive Power On or Off in an L25 Library

To turn drive power on or off in an L25 library:

- 1 Access the **Maintenance** screen (see [Accessing the Maintenance Screen](#) on page 77).
- 2 Press **Drv Pwr**.

The GUI displays the **Drive Power** screen (see [figure 43](#)).

Figure 43 Sample  
Drive Power Screen

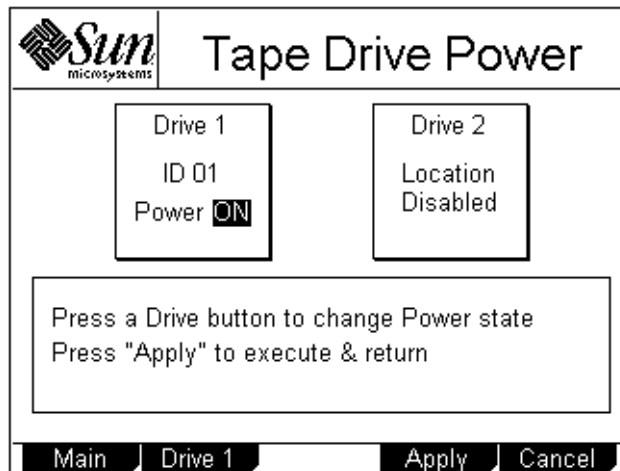

- 3 Press the button that corresponds to the drive you wish to power on or off: **Drive 1** or **Drive 2**.

The GUI displays the currently selected setting in the tape drive box at the top of the screen.

- 4 Press **Apply** to save the change and return to the **Quick View Menu** screen.

To return to the **Quick View Menu** screen without changing the power state of the drive, press **Cancel**.

### Turning Drive Power On or Off in an L100 Library

To turn drive power on or off in an L100 library:

- 1 Access the **Maintenance** screen (see [Accessing the Maintenance Screen](#) on page 77).
- 2 Press **Drv Pwr**.

The GUI displays the **Drive Power** screen (see [figure 44](#)).

Figure 44 Drive Power Screen

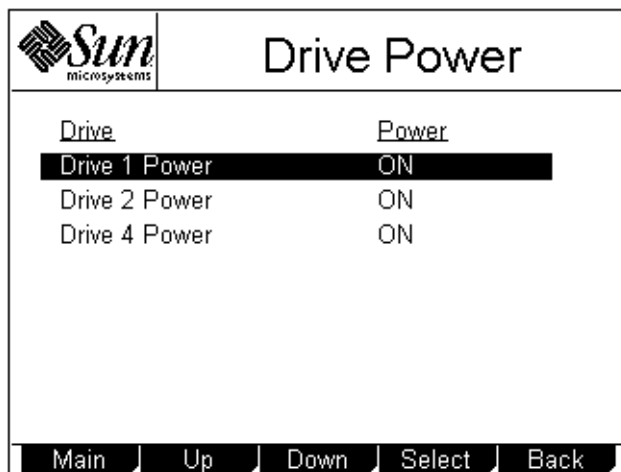

- 3 Press the **Up** or **Down** buttons to highlight the drive you wish to power on or off.
- 4 Press **Select**.  
The drive power setting is highlighted.
- 5 Press the **Up** or **Down** buttons to change the current setting.
- 6 When the desired setting is displayed, press **Select**.
- 7 Press **Back** to save the change and return to the **Maintenance** screen.

---

## Adjusting the Contrast

To adjust the contrast of the GUI:

- 1 Access the **Maintenance** screen (see [Accessing the Maintenance Screen](#) on page 77).
- 2 Press **Contrast**.

The GUI displays the **Adjust Contrast** screen (see [figure 45](#)).

---

Figure 45 Adjust Contrast Screen

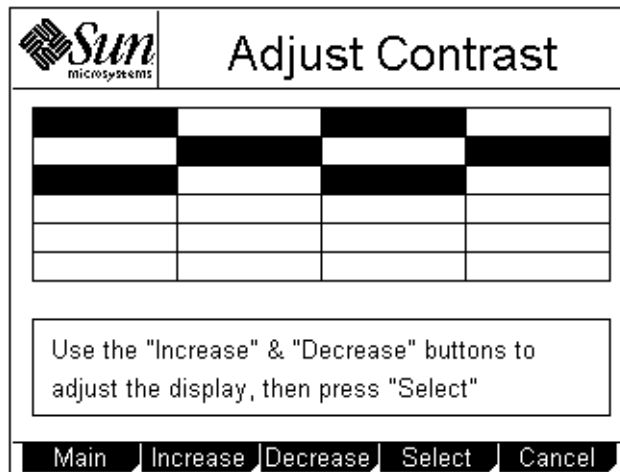

- 3 Press **Increase** or **Decrease** to adjust the contrast as desired.
- 4 When the desired contrast is selected, press **Select**.

To return to the **Maintenance** screen without changing the contrast, press **Cancel**.

## Chapter 5

# Running Diagnostic Programs

---

This chapter explains how to use the diagnostic programs that are available to all users through the **Diagnostics Menu** screen.

**Note:** This chapter does not describe the diagnostic programs that require a service key. Programs that require a service key are for authorized field service engineers only.

---

## Accessing the Diagnostics Menu Screen

To access the **Diagnostics Menu** screen:

- 1 On the main screen, press **Menu**.

The GUI displays the **Menu** screen.

- 2 Press **Service**.

The GUI displays the **Service Menu** screen.

Figure 46 Service Menu Screen

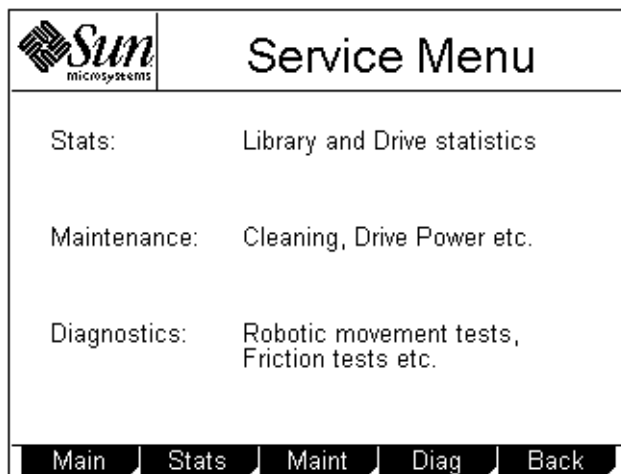

**3 Press Diag.**

The GUI displays the **Diagnostics Menu** screen (see [figure 47](#)).

Figure 47 Diagnostics Menu Screen

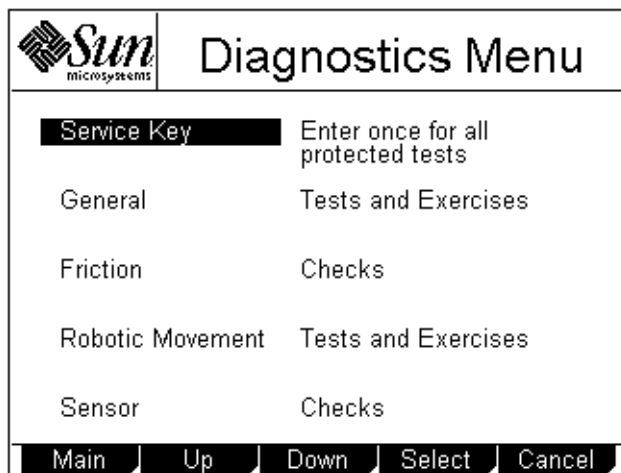

## Running the Barcode Scanner Test

The **Barcode Scanner** test causes the bar code scanner to do a complete inventory of the library, scanning each magazine location for the presence of a valid bar code label.

To run the **Barcode Scanner** test:

- 1 Access the **Diagnostics Menu** screen (see [Accessing the Diagnostics Menu Screen](#)).
- 2 Press the **Up** and **Down** buttons to select **General**.
- 3 Press **Select**.

The GUI displays the **Diags: General** screen (see [figure 48](#)).

Figure 48 Diags:  
General Screen

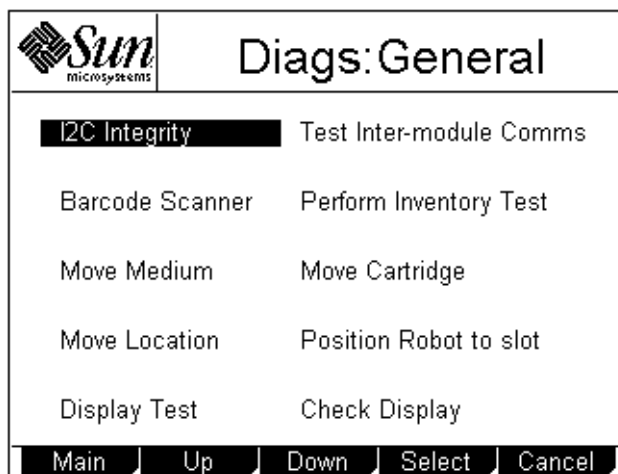

- 4 Press the **Up** and **Down** buttons to select **Barcode Scanner**.
- 5 Press **Select**.

The GUI displays the **Diag: Barcode** screen, which prompts you to set the cycle count (see [figure 49](#)). The rightmost number is highlighted.

Figure 49 Diag:  
Barcode Screen

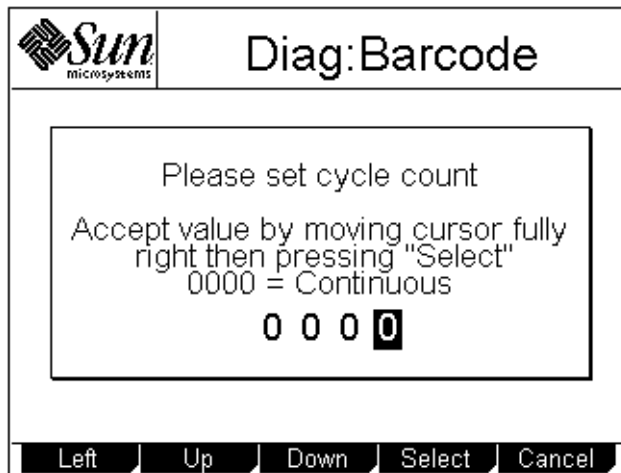

- 6 Press the **Up** and **Down** buttons to change the highlighted number.
- 7 Press **Left** to move the highlight to the next number.
- 8 Repeat steps [6](#) and [7](#) as necessary until the desired cycle count number is displayed.

**Note:** Setting the cycle count to 0000 causes the test to run continuously.

- 9 Press **Right** until the cursor is all the way to the right and the **Select** button appears.
- 10 Press **Select** to set the cycle count, or press **Cancel** to return to the **Diags: General** screen without running the **Barcode Scanner** test.

The test starts and the GUI displays a **Running Diag** screen. The test stops automatically after completing the selected number of cycles. When the test is complete, the GUI displays a screen indicating the test status.

To abort the test before it completes the selected number of cycles, press **Stop**.

- 11 Press **Back** to return to the **Diags: General** screen.



## Running the Move Medium Test

The **Move Medium** test simulates the movements performed when a SCSI Move Medium command is received via the SCSI interface.

To run the **Move Medium** test:

- 1 Access the **Diagnostics Menu** screen (see [Accessing the Diagnostics Menu Screen](#) on page 85).

- 2 Press the **Up** and **Down** buttons to select **General**.

- 3 Press **Select**.

The GUI displays the **Diags: General** screen (see [figure 48](#)).

- 4 Press the **Up** or **Down** buttons to select **Move Medium**.

- 5 Press **Select**.

The GUI displays the **Move Cartridge FROM** screen (see [figure 50](#)). A flashing arrow indicates the currently selected source element.

Figure 50 Sample Move Cartridge FROM Screen

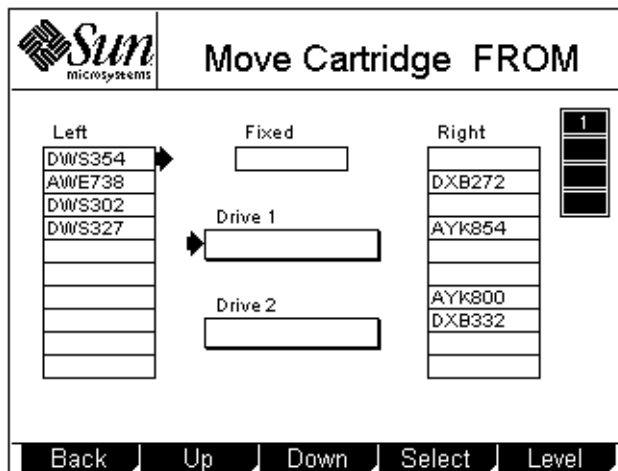

- 6 Press the **Level** button to select the level when the desired source element is located.

- 7 Press the **Up** and **Down** buttons to select the source element of the cartridge.
- 8 When the flashing arrow is next to the desired source element, press **Select**.

The GUI displays the **Move Cartridge TO** screen (see [figure 51](#)). A flashing arrow indicates the currently selected destination element.

Figure 51 Move Cartridge TO Screen

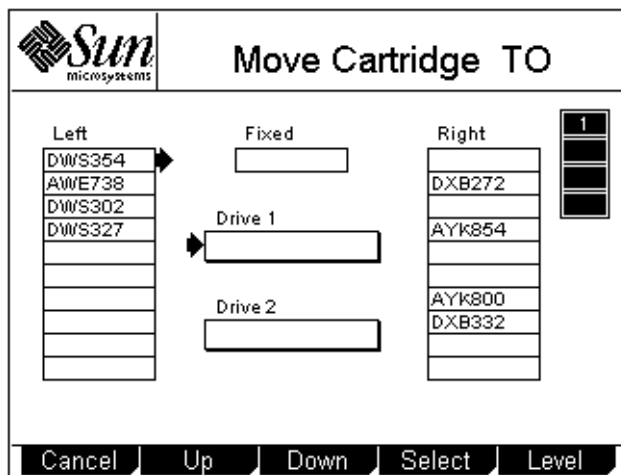

- 9 Press the **Level** button to select the level where the desired destination element is located.
- 10 Press the **Up** and **Down** buttons to select the destination element for the cartridge.
- 11 When the flashing arrow is next to the desired destination element, press **Select**.

The GUI displays the **Confirm Move Cartridge** screen (see [figure 52](#)).

Figure 52 Sample Confirm Move Cartridge Screen

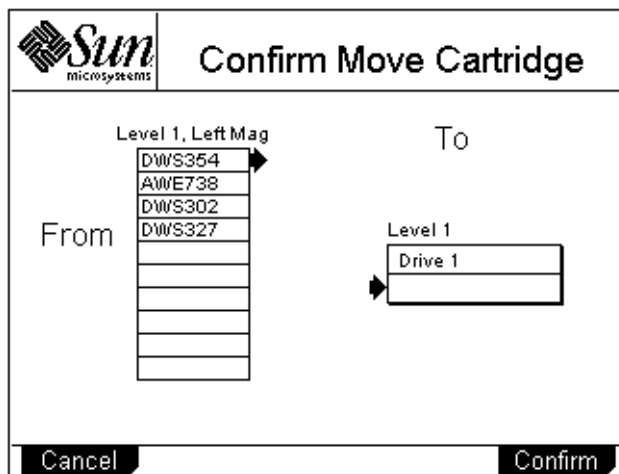

- 12 Verify that the GUI displays the correct source and destination elements, then press **Confirm**.

The GUI displays the **Diag: Move Medium** screen, which prompts you to set the cycle count (see [figure 53](#)). The rightmost number is highlighted.

Figure 53 Diag: Move Medium Screen

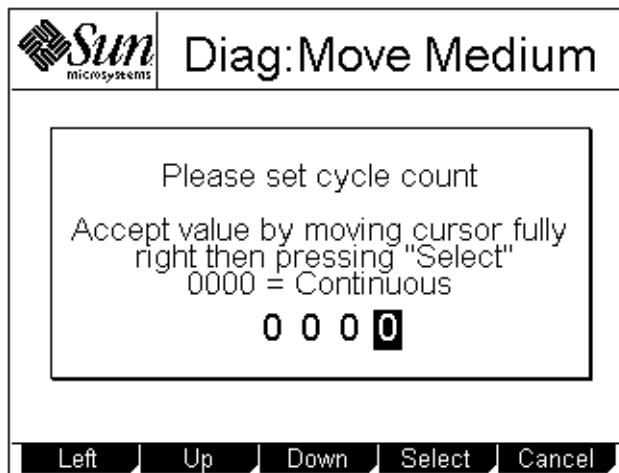

- 13 Press the **Up** and **Down** buttons to change the highlighted number.

- 14 Press **Left** to move the highlight to the next number.
- 15 Repeat steps [13](#) and [14](#) as necessary until the desired cycle count number is displayed.

**Note:** Setting the cycle count to 0000 causes the test to run continuously.

- 16 Press **Right** until the cursor is all the way to the right and the **Select** button appears.
- 17 Press **Select** to set the cycle count, or press **Cancel** to return to the **Diags: General** screen without running the **Move Medium** test.

The test starts and the GUI displays a **Running Diag** screen. The test stops automatically after completing the selected number of cycles. When the test is complete, the GUI displays a screen indicating the test status.

To abort the test before it completes the selected number of cycles, press **Stop**.

- 18 Press **Back**.

The GUI displays the cycle count screen.

- 19 Press **Cancel**, then **Back** to return to the **Diags: General** screen.

---

## Running the Move Location Test

The **Move Location** test is similar to the **Move Medium** test, except that no cartridges are actually moved.

When the **Move Location** test is cycled once, the robotic hand is moved from its current location to the destination location.

When the **Move Location** test is cycled more than once, the robotic hand is repeatedly moved between the destination location and a home location, and will return to the home location at the end of

the selected number of test cycles. The home location depends on whether the destination is a tape drive or a magazine slot:

- If the destination is a tape drive, the home location is slot 1 of the level 1 left magazine.
- If the destination is a magazine slot, the home location is tape drive 1.

To run the **Move Location** test:

- 1 Access the **Diagnostics Menu** screen (see [Accessing the Diagnostics Menu Screen](#) on page 85).
- 2 Press the **Up** and **Down** buttons to select **General**.
- 3 Press **Select**.

The GUI displays the **Diags: General** screen (see [figure 48](#) on page 87).

- 4 Press the **Up** or **Down** buttons to select **Move Location**.
- 5 Press **Select**.

The GUI displays the **Diag: Move-Location** screen (see [figure 54](#)).

Figure 54 Diag:  
Move-Location Screen

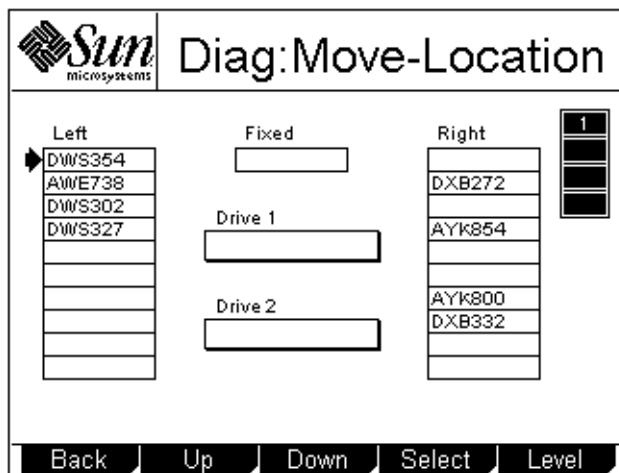

- 6 Press the **Up** and **Down** buttons to select the destination for the robotic hand.
- 7 Press **Select**.

The GUI displays the **Diag: Move Location** screen, which prompts you to set the cycle count (see [figure 55](#)). The rightmost number is highlighted.

Figure 55 Diag: Move Location Screen



- 8 Press the **Up** and **Down** buttons to change the highlighted number.
- 9 Press **Left** to move the highlight to the next number.
- 10 Repeat steps [8](#) and [9](#) as necessary until the desired cycle count number is displayed.

**Note:** Setting the cycle count to 0000 causes the test to run continuously.

- 11 Press **Right** until the cursor is all the way to the right and the **Select** button appears.
- 12 Press **Select** to set the cycle count, or press **Cancel** to return to the **Diags: General** screen without running the **Move Location** test.

The test starts and the GUI displays a **Running Diag** screen. The test stops automatically after completing the selected number of cycles. When the test is complete, the GUI displays a screen indicating the test status.

To abort the test before it completes the selected number of cycles, press **Stop**.

- 13 Press **Back**.

The GUI displays the cycle count screen.

- 14 Press **Cancel**, then **Back** to return to the **Diags: General** screen.

---

## Running the Display Test

The **Display Test** allows you to verify that the GUI has no missing pixels and that the two status indicators on the library front panel work correctly.

To run the **Display Test**:

- 1 Access the Diagnostics Menu screen (see [Accessing the Diagnostics Menu Screen](#) on page 85).
- 2 Press the **Up** and **Down** buttons to select **General**.
- 3 Press **Select**.

The GUI displays the **Diags: General** screen (see [figure 48](#) on page 87).

- 4 Press the **Up** and **Down** buttons to select **Display Test**.
- 5 Press **Select**.

The test starts. The GUI goes dark momentarily, and both of the status indicators flash. This test lasts approximately three seconds.





## Chapter 6

# Running the Demonstration Programs

---

The L25 and L100 provide several built-in demonstration programs and a confidence test you can use to check whether the robotics are functioning properly. You can access these programs through the **Demo Programs** screen.

**Caution:** Do not use backup tapes to run these programs. These programs move cartridges around the library; the cartridges will not be in the same position when the program ends.

---

## Accessing the Demo Programs Screen

To access the **Demo Programs** screen:

- 1 On the main screen, press **Menu**.

The GUI displays the **Menu** screen.

- 2 Press **Demo**.

The GUI displays the **Demo Programs** screen (see [figure 56](#)).

Figure 56 Demo Programs Screen

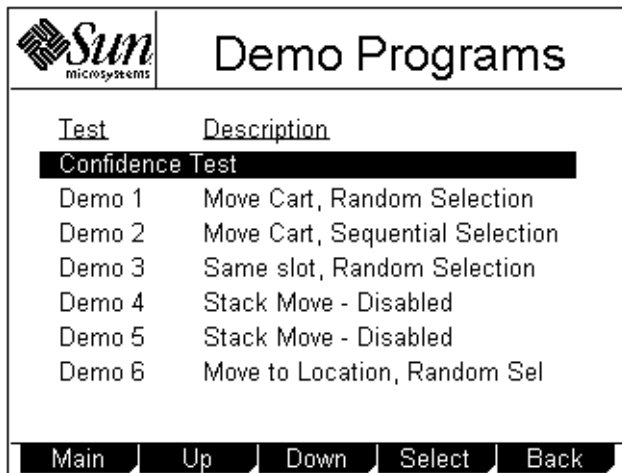

Test	Description
Confidence Test	
Demo 1	Move Cart, Random Selection
Demo 2	Move Cart, Sequential Selection
Demo 3	Same slot, Random Selection
Demo 4	Stack Move - Disabled
Demo 5	Stack Move - Disabled
Demo 6	Move to Location, Random Sel

## Running the Confidence Test Program

The **Confidence Test** program moves a data cartridge to each tape drive, each magazine, and the fixed slot. The test ends automatically when the cartridge has been placed in all tape drives, magazines, and fixed slots in the library.

To run the **Confidence Test** program:

- 1 Load a single data cartridge into the top left magazine.

**Note:** Leave all the other magazine slots empty.

- 2 Access the **Demo Programs** screen (see [Accessing the Demo Programs Screen](#)).
- 3 Press the **Up** or **Down** buttons to select **Confidence Test**.
- 4 Press **Select**.

The **Confidence Test** program ends automatically when complete.

---

## Running the Demo 1 Program

The **Demo 1** program causes the robot to pick a randomly selected cartridge from its magazine slot and place it in another randomly selected magazine slot.

To run the **Demo 1** program:

- 1 Verify that at least one magazine is installed in the library and that at least one cartridge is present.
- 2 Access the **Demo Programs** screen (see [Accessing the Demo Programs Screen](#)).
- 3 Press the **Up** or **Down** buttons to select **Demo 1**.
- 4 Press **Select**.

The **Demo 1** program starts. This program continues until you press the **Stop** button.

- 5 If desired, include the drives or the fixed slot in the test:
  - a Press the **Level** button to select the level where the desired drive or fixed slot is located.
  - b Press **Drive 1** or **Drive 2** to include a drive.
  - c Press **Fixed** to include the fixed slot.
- 6 To stop the program, press **Stop**.

The GUI displays a status screen listing the demonstration program number, the number of cycles completed, and the status of the test: pass or fail.

- 7 Press **Back** to return to the **Demo Programs** screen.

---

## Running the Demo 2 Program

The **Demo 2** program causes the robot to pick a cartridge from the first occupied magazine slot and place it in the next vacant magazine slot. The robot then moves to the next occupied slot and repeats the process.

To run the **Demo 2** program:

- 1 Verify that at least one magazine is installed in the library and that at least one cartridge is present.
- 2 Access the **Demo Programs** screen (see [Accessing the Demo Programs Screen](#)).
- 3 Press the **Up** or **Down** buttons to select **Demo 2**.
- 4 Press **Select**.

The **Demo 2** program starts. This program continues until you press the **Stop** button.

- 5 If desired, include the drives or the fixed slot in the test:
  - a Press the **Level** button to select the level where the desired drive or fixed slot is located.
  - b Press **Drive 1** or **Drive 2** to include a drive.
  - c Press **Fixed** to include the fixed slot.
- 6 To stop the program, press **Stop**.

The GUI displays a status screen listing the demonstration program number, the number of cycles completed, and the status of the test: pass or fail.

- 7 Press **Back** to return to the **Demo Programs** screen.

---

## Running the Demo 3 Program

The **Demo 3** program causes the robot to pick a cartridge from a randomly selected occupied magazine slot and place it back in the same slot. The robot then moves to another randomly selected occupied slot and repeats the process.

To run the **Demo 3** program:

- 1 Verify that at least one magazine is installed in the library and that at least one cartridge is present.
- 2 Access the **Demo Programs** screen (see [Accessing the Demo Programs Screen](#)).
- 3 Press the **Up** or **Down** buttons to select **Demo 3**.
- 4 Press **Select**.

The **Demo 3** program starts. This program continues until you press the **Stop** button.

- 5 If desired, include the drives or the fixed slot in the test:
  - a Press the **Level** button to select the level where the desired drive or fixed slot is located.
  - b Press **Drive 1** or **Drive 2** to include a drive.
  - c Press **Fixed** to include the fixed slot.
- 6 To stop the program, press **Stop**.

The GUI displays a status screen listing the demonstration program number, the number of cycles completed, and the status of the test: pass or fail.

- 7 Press **Back** to return to the **Demo Programs** screen.

---

## Running the Demo 4 Program

The **Demo 4** program causes the robot to pick a randomly selected cartridge from its magazine slot and place it in another randomly selected magazine slot.

**Note:** This program is for stacked libraries only.

To run the **Demo 4** program:

- 1 Verify that at least:
  - Two library modules are installed in the stack
  - One magazine is installed in each library module
  - One cartridge is present
- 2 Access the **Demo Programs** screen (see [Accessing the Demo Programs Screen](#) on page 97).
- 3 Press the **Up** or **Down** buttons to select **Demo 4**.
- 4 Press **Select**.

The **Demo 4** program starts. This program continues until you press the **Stop** button.

- 5 To stop the program, press **Stop**.

The GUI displays a status screen listing the demonstration program number, the number of cycles completed, and the status of the test: pass or fail.

- 6 Press **Back** to return to the **Demo Programs** screen.

---

## Running the Demo 5 Program

The **Demo 5** program causes the robot to pick a randomly selected cartridge from its magazine slot and place it in another magazine slot on another level of the stacked library. This test maximizes the use of the StackLink.

**Note:** This program is for stacked libraries only.

To run the **Demo 5** program:

- 1 Verify that at least:
  - Two library modules are installed in the stack
  - One magazine is installed in each library module
  - One cartridge is present
- 2 Access the **Demo Programs** screen (see [Accessing the Demo Programs Screen](#) on page 97).
- 3 Press the **Up** or **Down** buttons to select **Demo 5**.
- 4 Press **Select**.

The **Demo 5** program starts. This program continues until you press the **Stop** button.

- 5 To stop the program, press **Stop**.

The GUI displays a status screen listing the demonstration program number, the number of cycles completed, and the status of the test: pass or fail.

- 6 Press **Back** to return to the **Demo Programs** screen.

## Running the Demo 6 Program

The **Demo 6** program causes the X, Y, and Theta axes to move randomly.

To run the **Demo 6** program:

- 1 Access the **Demo Programs** screen (see [Accessing the Demo Programs Screen](#) on page 97).
- 2 Press the **Up** or **Down** buttons to select **Demo 6**.
- 3 Press **Select**.

The **Demo 6** program starts.

- 4 To stop the program, press **Stop**.

The GUI displays a status screen listing the demonstration program number, the number of cycles completed, and the status of the test: pass or fail.

- 5 Press **Back** to return to the **Demo Programs** screen.



## Appendix A

# Specifications

---

This appendix lists the following specifications for the L25 and L100 libraries:

- Physical
- Performance
- Reliability
- Environmental
- Tape drive

## Physical Specifications

Table 6 Unit  
Dimensions/Weight

	<b>L25</b>	<b>L100</b>
<b>Width</b>	19 in. (482 mm)	19 in. (482 mm)
<b>Depth</b>	28.6 in. (726 mm)	28.6 in. (726 mm)
<b>Height</b>	6.9 in. (176 mm)	23.4 in. (595 mm)
<b>Weight</b>	69 lbs. (31kg) with 2 drives, 2 magazines, and 0 cartridges installed	207 lbs. (94 kg) with 5 drives, 8 magazines, and 0 cartridges installed  214 lbs. (97 kg) with 6 drives, 7 magazines, and 0 cartridges installed

Table 7 Capacities

	<b>L25</b>	<b>L100</b>
<b>Number of Tape Drives</b>	Up to 2	Up to 6
<b>Type of Tape Drives</b>	DLT 8000, SDLT, or LTO	
<b>Number of Tape Cartridges</b>	Up to 20 DLT or SDLT tape cartridges (excluding the fixed slot)  Up to 24 LTO tape cartridges (excluding the fixed slot)	Up to 80 DLT or SDLT tape cartridges (excluding the fixed slots)  Up to 96 LTO tape cartridges (excluding the fixed slots)

	L25	L100
<b>Type of Tape Cartridges</b>	For use with: <ul style="list-style-type: none"> <li>• DLT 8000 drives: DLTtape III or DLTtape IV</li> <li>• SDLT drives: DLTtape IV* or Super DLTtape 1</li> <li>• LTO drives: LTO Ultrium cartridges</li> </ul>	
<b>Number of Magazines</b>	Up to 2	Up to 8
<b>Magazine Capacity</b>	Each magazine holds up to 10 DLT or SDLT tape cartridges or up to 12 LTO tape cartridges	
<b>Manual Access Facility</b>	Yes	Yes
<b>Cleaning Cartridge/ Extra Data Slots</b>	1	4
<b>Robot Mounted Bar Code Reader</b>	Yes	Yes
<b>StackLink Scalability</b>	Yes	Yes

\* SDLT read only

## Performance Specifications

Table 8 Performance Specifications

	L25	L100
<b>Average Swap Time</b>	Less than 10 seconds	Less than 11 seconds

Table 9 Library  
Performance

		<b>Data Capacity (Excluding Fixed Slots)</b>	<b>Maximum Data Capacity (Including Fixed Slots)</b>	<b>Maximum Data Throughput</b>	<b>Host Interfaces</b>
<b>L25</b>	<b>DLT 8000</b>	1.6 TB*	1.68 TB*	86.4 GB/hr*	HVD SCSI-2 Fast/Wide
	<b>SDLT</b>	4.4 TB*	4.62 TB*	158.4 GB/hr*	HVD, Ultra 2 SCSI
	<b>LTO</b>	4.8 TB*	5 TB*	216 GB/hr*	HVD, Ultra 2 SCSI
<b>L100</b>	<b>DLT 8000</b>	6.4 TB*	6.72 TB*	59.2 GB/hr*	HVD SCSI-2 Fast/Wide
	<b>SDLT</b>	17.6 TB*	18.48 TB*	475.2 GB/hr*	HVD, Ultra 2 SCSI
	<b>LTO</b>	19.2 TB*	20 TB*	648 GB/hr*	HVD, Ultra 2 SCSI

\* Assuming 2:1 compression ratios

## Reliability Specifications

Table 10 Reliability  
Specifications

<b>MSBF</b>	Swap cycles 1,000,000 swaps
<b>MTTR</b>	Less than 20 minutes

## Tape Drive Specifications

Table 11 Tape Drive Specifications

Model Number	Native Mode		With 2:1 Compression	
	Transfer Rate	Capacity	Transfer Rate	Capacity
DLT 8000*	360 MB/min.	40 GB	720 MB/min.	80 GB
SDLT†	660 MB/min.	110 GB	1320 MB/min.	220 GB
LTO	900 MB/min.	100 GB	1800 MB/min.	200 GB

\* Average file access time (from BOT) = 60 seconds

† Average file access time (from BOT) = 70 seconds

## Environmental Specifications

Table 12 Power

		L25	L100
Electrical Input Tolerances	Voltage	88-264 VAC, 47-63 Hz	
	Power	110W (average)	300W (average) (6 drives fitted)

Table 13 Climate

	Temperature (Operating)	Temperature (Non-Operating)
Temperature	+50°F to 104°F (+10°C to +40°C)	-22°F to +122°F (-30°C to +50°F)

	<b>Temperature (Operating)</b>	<b>Temperature (Non-Operating)</b>
<b>Humidity</b>	20% to 80% non-condensing	5% to 90% non-condensing
<b>Altitude</b>	-1,000 to +10,000 feet (-300 to +3,000 meters)	-1,000 to +36,000 feet (-300 to +11,000 meters)

Table 14 Compliance and Certification

<b>Safety</b>	CSA C22.2 950, UL 1950, EN 60950
<b>EMC/RFI</b>	FCC CFR 47-15J (level A), EN55022 (CISPR 22) level B, EN55024 (CISPR 24), VCCI
<b>Agency Markings</b>	CE, VCCI, UL, FCC, CSA

## Appendix B

# Fault Symptom Code (FSC) Dictionary

---

[Table 15](#) lists the fault symptom codes (FSCs) for the L25 and L100 libraries.

Table 15 Fault Symptom Codes

FSC	Name	Description	FRU Name	Confidence %
0001	FSC_DIVIDE_BY_ZERO	A divide by zero exception has occurred	Microcode	100%
0002	FSC_BUS_PARITY_ERROR	A parity error has been detected on the address/data bus	N/A	100%
0003	FSC_NO_MEMORY	Out of memory	Microcode	100%
0004	FSC_FLSBUF_CALLED	_flsbuf was called	Microcode	100%
0005	FSC_GETBUF_CALLED	_getbuf was called	Microcode	100%
0006	FSC_STACK_ERROR	Stack was exhausted	Microcode	100%
0007	FSC_FLOAT_TRAP	Floating point trap	Microcode	100%

Appendix B Fault Symptom Code (FSC) Dictionary

<b>FSC</b>	<b>Name</b>	<b>Description</b>	<b>FRU Name</b>	<b>Confidence %</b>
0008	FSC_BAD_FREE	Free() called on bad memory block	Microcode	100%
0009	FSC_BAD_REALLOC	Realloc() called on bad memory block	Microcode	100%
000A	FSC_HAND_CV	Hand CV check found hand disconnected	Microcode	100%
000B	FSC_SERVO_CV	Servo CV check found servo board disconnected	Microcode	100%
000C	FSC_X_AXIS_CV	X axis CV check found X axis disconnected	Microcode	100%
000D	FSC_Y_AXIS_CV	Y axis CV check found Y axis disconnected	Microcode	100%
000E	FSC_Z_AXIS_CV	Z axis CV check found Z axis disconnected	Microcode	100%
000F	FSC_FP_CV	FP CV check found front panel disconnected	Microcode	100%
0010	FSC_BAD_FREE_TRAILER	Free() found corrupted memory block trailer	Microcode	100%
0011	FSC_BAD_REALLOC_TRAILER	Realloc() found corrupted memory block trailer	Microcode	100%
0012	FSC_NVR_OVERFLOW	NVR capacity exceeded	Microcode	100%
0013	FSC_BAD_MALLOC_BLOCK_HDR	Heap consistency check found corruption	Microcode	100%



<b>FSC</b>	<b>Name</b>	<b>Description</b>	<b>FRU Name</b>	<b>Confidence %</b>
0014	FSC_BAD_MALLOC_BLOCK_TRAILER	Heap consistency check found corruption	Microcode	100%
0015	FSC_WATCHDOG_ERROR	An unexpected non-maskable interrupt has occurred	Microcode	100%
0016	FSC_MALLOC_REQUEST_TOO_BIG	Size passed to malloc too large	Microcode	100%
0017	FSC_CALLOC_REQUEST_TOO_BIG	Size passed to calloc too large	Microcode	100%
0018	FSC_REALLOC_REQUEST_TOO_BIG	Size passed to realloc too large	Microcode	100%
0019	FSC_EXCEPTION_3	Breakpoint instruction executed	Microcode	100%
001A	FSC_EXCEPTION_1	Debug exception occurred	Microcode	100%
001B	FSC_NULL_POINTER_WRITE	Code attempted to write to address 0	Microcode	100%
001C	FSC_EXECUTE_AT_0	Code attempted to execute at address 0	Microcode	100%
001D	FSC_NULL_POINTER_WRITE_NEAR	Code attempted to write to address 0	Microcode	100%
001E	FSC_EXECUTE_AT_0_NEAR	Code attempted to execute at address 0	Microcode	100%
001F	FSC_UNSUPPORTED_SYSTEM_BOARD	Old system boards are no longer supported	Microcode	100%
0020	FSC_NO_OSTIMER_INTERRUPT	OS timer interrupt should have occurred, but hasn't	Microcode	100%

<b>FSC</b>	<b>Name</b>	<b>Description</b>	<b>FRU Name</b>	<b>Confidence %</b>
1000	FSC_FPGA_INIT_STUCK_HI	FPGA INIT pin was detected as being high when it should have been low	System	100%
1001	FSC_FPGA_INIT_NOT_HI	FPGA INIT pin was detected as being low when it should have been high	System	100%
1002	FSC_FPGA_DONE_STUCK_HI	FPGA DONE pin was detected as being high when it should have been low	System	100%
1003	FSC_FPGA_DONE_NOT_HI	FPGA DONE pin was detected as being low when it should have been high	System	100%
2000	FSC_DLT_INIT_FAILED	DLT initialization failed	Microcode	100%
2001	FSC_DRIVE_TIMEOUT_1	Drive time out waiting for status (drive 1)	Drive	100%
2002	FSC_DRIVE_TIMEOUT_2	Drive time out waiting for status (drive 2)	Drive	100%
2003	FSC_DRIVE_TIMEOUT_3	Drive time out waiting for status (drive 3)	Drive	100%
2004	FSC_DRIVE_TIMEOUT_4	Drive time out waiting for status (drive 4)	Drive	100%
2005	FSC_DRIVE_TIMEOUT_5	Drive time out waiting for status (drive 5)	Drive	100%
2006	FSC_DRIVE_TIMEOUT_6	Drive time out waiting for status (drive 6)	Drive	100%

<b>FSC</b>	<b>Name</b>	<b>Description</b>	<b>FRU Name</b>	<b>Confidence %</b>
2007	FSC_DRIVE_TIMEOUT_7	Drive time out waiting for status (drive 7)	Drive	100%
2008	FSC_DRIVE_TIMEOUT_8	Drive time out waiting for status (drive 8)	Drive	100%
2009	FSC_DRIVE_OLD_SYSTEM_BOARD	Requires newer version of system board	System	100%
200A	FSC_DRIVE_NOT_PRESENT_1	Drive caddy not present (drive 1)	Drive	100%
200B	FSC_DRIVE_NOT_PRESENT_2	Drive caddy not present (drive 2)	Drive	100%
200C	FSC_DRIVE_NOT_PRESENT_3	Drive caddy not present (drive 3)	Drive	100%
200D	FSC_DRIVE_NOT_PRESENT_4	Drive caddy not present (drive 4)	Drive	100%
200E	FSC_DRIVE_NOT_PRESENT_5	Drive caddy not present (drive 5)	Drive	100%
200F	FSC_DRIVE_NOT_PRESENT_6	Drive caddy not present (drive 6)	Drive	100%
2010	FSC_DRIVE_NOT_PRESENT_7	Drive caddy not present (drive 7)	Drive	100%
2011	FSC_DRIVE_NOT_PRESENT_8	Drive caddy not present (drive 8)	Drive	100%
2012	FSC_INVALID_STUFF_BYTE_1	Invalid byte received from drive 1	Drive	100%
2013	FSC_INVALID_STUFF_BYTE_2	Invalid byte received from drive 2	Drive	100%
2014	FSC_INVALID_STUFF_BYTE_3	Invalid byte received from drive 3	Drive	100%

Appendix B Fault Symptom Code (FSC) Dictionary

<b>FSC</b>	<b>Name</b>	<b>Description</b>	<b>FRU Name</b>	<b>Confidence %</b>
2015	FSC_INVALID_STUFF_BYTE_4	Invalid byte received from drive 4	Drive	100%
2016	FSC_INVALID_STUFF_BYTE_5	Invalid byte received from drive 5	Drive	100%
2017	FSC_INVALID_STUFF_BYTE_6	Invalid byte received from drive 6	Drive	100%
2018	FSC_INVALID_STUFF_BYTE_7	Invalid byte received from drive 7	Drive	100%
2019	FSC_INVALID_STUFF_BYTE_8	Invalid byte received from drive 8	Drive	100%
201A	FSC_INVALID_PACKET_1	Invalid packet received from drive 1	Drive	100%
201B	FSC_INVALID_PACKET_2	Invalid packet received from drive 2	Drive	100%
201C	FSC_INVALID_PACKET_3	Invalid packet received from drive 3	Drive	100%
201D	FSC_INVALID_PACKET_4	Invalid packet received from drive 4	Drive	100%
201E	FSC_INVALID_PACKET_5	Invalid packet received from drive 5	Drive	100%
201F	FSC_INVALID_PACKET_6	Invalid packet received from drive 6	Drive	100%
2020	FSC_INVALID_PACKET_7	Invalid packet received from drive 7	Drive	100%
2021	FSC_INVALID_PACKET_8	Invalid packet received from drive 8	Drive	100%
2022	FSC_NOT_IMPLEMENTED	The requested function is not implemented in the drive type	Drive	100%

<b>FSC</b>	<b>Name</b>	<b>Description</b>	<b>FRU Name</b>	<b>Confidence %</b>
2023	FSC_DRIVE_NO_RESOURCE	Couldn't get semaphore from OS	Microcode	100%
2024	FSC_COMMAND_FAILED_1	Response packet received from drive 1 indicates command failed	Drive	100%
2025	FSC_COMMAND_FAILED_2	Response packet received from drive 2 indicates command failed	Drive	100%
2026	FSC_COMMAND_FAILED_3	Response packet received from drive 3 indicates command failed	Drive	100%
2027	FSC_COMMAND_FAILED_4	Response packet received from drive 4 indicates command failed	Drive	100%
2028	FSC_COMMAND_FAILED_5	Response packet received from drive 5 indicates command failed	Drive	100%
2029	FSC_COMMAND_FAILED_6	Response packet received from drive 6 indicates command failed	Drive	100%
202A	FSC_COMMAND_FAILED_7	Response packet received from drive 7 indicates command failed	Drive	100%

<b>FSC</b>	<b>Name</b>	<b>Description</b>	<b>FRU Name</b>	<b>Confidence %</b>
202B	FSC_COMMAND_FAILED_8	Response packet received from drive 8 indicates command failed	Drive	100%
202C	FSC_SEAGATE_SCSI_CMD_ERROR_1	Response packet received from drive 1 indicates command failed	Drive	100%
202D	FSC_SEAGATE_SCSI_CMD_ERROR_2	Response packet received from drive 2 indicates command failed	Drive	100%
202E	FSC_SEAGATE_SCSI_CMD_ERROR_3	Response packet received from drive 3 indicates command failed	Drive	100%
202F	FSC_SEAGATE_SCSI_CMD_ERROR_4	Response packet received from drive 4 indicates command failed	Drive	100%
2030	FSC_SEAGATE_SCSI_CMD_ERROR_5	Response packet received from drive 5 indicates command failed	Drive	100%
2031	FSC_SEAGATE_SCSI_CMD_ERROR_6	Response packet received from drive 6 indicates command failed	Drive	100%
2032	FSC_SEAGATE_SCSI_CMD_ERROR_7	Response packet received from drive 7 indicates command failed	Drive	100%

<b>FSC</b>	<b>Name</b>	<b>Description</b>	<b>FRU Name</b>	<b>Confidence %</b>
2033	FSC_SEAGATE_SCSI_CMD_ERROR_8	Response packet received from drive 8 indicates command failed	Drive	100%
2034	FSC_HP_BUSY_1	Response packet received from drive 1 indicates drive busy	Drive	100%
2035	FSC_HP_BUSY_2	Response packet received from drive 2 indicates drive busy	Drive	100%
2036	FSC_HP_BUSY_3	Response packet received from drive 3 indicates drive busy	Drive	100%
2037	FSC_HP_BUSY_4	Response packet received from drive 4 indicates drive busy	Drive	100%
2038	FSC_HP_BUSY_5	Response packet received from drive 5 indicates drive busy	Drive	100%
2039	FSC_HP_BUSY_6	Response packet received from drive 6 indicates drive busy	Drive	100%
203A	FSC_HP_BUSY_7	Response packet received from drive 7 indicates drive busy	Drive	100%
203B	FSC_HP_BUSY_8	Response packet received from drive 8 indicates drive busy	Drive	100%
2100	FSC_I2C_FAILED_INIT	I <sup>2</sup> C interface failed to initialize	Microcode	100%
2101	FSC_I2C_TIMEOUT_BUS_BUSY	Timed out waiting for I <sup>2</sup> C bus to go not busy	I <sup>2</sup> C	100%

Appendix B Fault Symptom Code (FSC) Dictionary

<b>FSC</b>	<b>Name</b>	<b>Description</b>	<b>FRU Name</b>	<b>Confidence %</b>
2102	FSC_I2C_NO_ACKNOWLEDGEMENT	No acknowledge received from slave	I <sup>2</sup> C	100%
2103	FSC_I2C_UNABLE_TO_SEND_MESSAGE	Exceeded retry limit while trying to send message	I <sup>2</sup> C	100%
2104	FSC_I2C_NO_RESPONSE_FROM_HARDWARE	Expected response from hardware was not received	I <sup>2</sup> C	100%
2105	FSC_I2C_UNKNOWN_MESSAGE_DESTINATION	Message received from I <sup>2</sup> C bus but destination is unknown	I <sup>2</sup> C	100%
2106	FSC_I2C_MESSAGE_TOO_BIG	Message to send over I <sup>2</sup> C bus is too big (see path)	I <sup>2</sup> C	100%
2107	FSC_I2C_RCV_MESSAGE_TOO_BIG	Message received over I <sup>2</sup> C bus is too big	I <sup>2</sup> C	100%
2108	FSC_I2C_MAILBOX_FULL	I <sup>2</sup> C mailbox is full	I <sup>2</sup> C	100%
2109	FSC_I2C_INVALID_RCV_ADDRESS	Receiver address in I <sup>2</sup> C message incorrect	I <sup>2</sup> C	100%
210A	FSC_I2C_STUCK_INTERRUPT	Pending interrupt status not reset	I <sup>2</sup> C	100%
2200	FSC_UI_NO_RESOURCE	UI task initialization failed	Microcode	100%
2201	FSC_UI_QUEUE_FULL	UI queue full	Microcode	100%
2202	FSC_UI_ACTION_IMPOSSIBLE	The UI is not in the correct state to perform the requested action	Microcode	100%



<b>FSC</b>	<b>Name</b>	<b>Description</b>	<b>FRU Name</b>	<b>Confidence %</b>
2301	FSC_BARCODE_TIMEOUT	Timed out waiting for data from barcode reader	Hand	100%
2302	FSC_BARCODE_READER_NOT_INSTALLED	Did not detect barcode reader	Hand	100%
2303	FSC_BARCODE_NO_READ	Barcode reader did not find a barcode	Microcode	100%
2400	FSC_LIBRARIAN_NO_RESOURCE	Librarian task initialization failed	Microcode	100%
2401	FSC_LIBRARIAN_BAD_MESSAGE	Librarian task received an unknown or unexpected message		
2402	FSC_LIBRARIAN_QUEUE_FULL	Librarian queue full	Microcode	100%
2403	FSC_LIBRARIAN_SRC_EMPTY	Source is empty	Microcode	100%
2404	FSC_LIBRARIAN_DEST_FULL	Destination is full	Microcode	100%
2405	FSC_LIBRARIAN_BAD_ELEMENT	Element address supplied is invalid	Microcode	100%
2406	FSC_LIBRARIAN_SERVO_INIT_FAILED	Servo initialization not complete (Librarian unsure of Servo status)	Microcode	100%
2407	FSC_LIBRARIAN_SERVO_DISABLED	Servo turned off due to failure (Librarian unsure of Servo status)	Microcode	100%
2408	FSC_LIBRARIAN_DEST_ABSENT	Destination slot not present (magazine or drive removed)	Microcode	100%

<b>FSC</b>	<b>Name</b>	<b>Description</b>	<b>FRU Name</b>	<b>Confidence %</b>
2409	FSC_LIBRARIAN_MAG_REMOVED	Magazine removed when door was shut	Microcode	100%
240A	FSC_LIBRARIAN_MAG_INSERTED	Magazine inserted when no access to it	Microcode	100%
240B	FSC_LIBRARIAN_NO_FREE_SLOTS	Demo stopped; no slot available for cartridge destination	Microcode	100%
240C	FSC_LIBRARIAN_NO_CARTRIDGES	Sequence stopped; no cartridge available to perform requested action	Microcode	100%
240D	FSC_LIBRARIAN_ROGUE_CARTRIDGE	Librarian uncertain of cartridge origin	Microcode	100%
240E	FSC_LIBRARIAN_CARTRIDGE_IN_SHUTTLE	Manual intervention required to remove cartridge from the shuttle	Microcode	100%
240F	FSC_LIBRARIAN_ACTION_IMPOSSIBLE_CARTRIDGE_IN_HAND	The requested move can not be performed	Microcode	100%
2410	FSC_LIBRARIAN_ACTION_IMPOSSIBLE_CARTRIDGE_IN_SHUTTLE	The requested move can not be performed	Microcode	100%
2411	FSC_LIBRARIAN_NO_CLEANING_TAPES	Auto-clean can not be performed as there are no cleaning tapes	Microcode	100%
2412	FSC_LIBRARIAN_CLEANING_TAPES_IN_USE	Auto-clean can not be performed as all the cleaning tapes are in use	Microcode	100%

<b>FSC</b>	<b>Name</b>	<b>Description</b>	<b>FRU Name</b>	<b>Confidence %</b>
2413	FSC_LIBRARIAN_SRC_ABSENT	Source slot not present (magazine or drive removed)	Microcode	100%
2414	FSC_LIBRARIAN_NO_START_SLOT	Demo unable to select random start slot (try re-running demo)	Microcode	100%
2415	FSC_LIBRARIAN_AUTOCLEAN_IN_PROGRESS	Move medium attempted to drive that is being auto cleaned	Microcode	100%
2416	FSC_LIBRARIAN_BAD_MESSAGE_PARAMETER	Bad parameter in Librarian message	Microcode	100%
2417	FSC_LIBRARIAN_DEDICATED_CLEANER	Fixed slot reserved for dedicated cleaner; not for general use	Microcode	100%
2418	FSC_LIBRARIAN_ROBOT_NOT_READY	Requested action can not be performed; robot is busy or in use	Microcode	100%
2419	FSC_LIBRARIAN_ILLEGAL_MAG_INSERTED	Magazine 5 present in 6 drive, 7 magazine configuration	Microcode	100%
241A	FSC_LIBRARIAN_NON_HOMOGENOUS_STACK	Stack contains modules configured for different media to stack-master	Microcode	100%
2500	FSC_SCSI_NO_RESOURCE	SCSI task initialization failed	Microcode	100%
2501	FSC_SCSI_BAD_MESSAGE	SCSI task received a bad message	Microcode	100%
2502	FSC_SCSI_QUEUE_FULL	SCSI queue full	Microcode	100%
2503	FSC_SCSI_NO_FAS366	FAS366 not detected	Servo/SCSI	100%

Appendix B Fault Symptom Code (FSC) Dictionary

<b>FSC</b>	<b>Name</b>	<b>Description</b>	<b>FRU Name</b>	<b>Confidence %</b>
2504	FSC_SCSI_INVALID_PAGE_CODE	Bad page code in send diagnostic	Host	100%
2600	FSC_SERVO_NO_RESOURCE	SERVO task initialization failed	Microcode	100%
2601	FSC_SERVO_QUEUE_FULL	SERVO queue full	Microcode	100%
2602	FSC_SERVO_X_AXIS_NOT_IN_POSITION	The X axis failed to get to its target position		
2603	FSC_SERVO_Y_AXIS_NOT_IN_POSITION	The Y axis failed to get to its target position		
2604	FSC_SERVO_THETA_AXIS_NOT_IN_POSITION	The THETA axis failed to get to its target position		
2605	FSC_SERVO_PICKER_AXIS_NOT_IN_POSITION	The PICKER axis failed to get to its target position		
2606	FSC_SERVO_SHUTTLE_AXIS_NOT_IN_POSITION	The Shuttle axis failed to get to its target position		
2607	FSC_SERVO_Z_AXIS_NOT_IN_POSITION	The Z axis failed to get to its target position		
2608	FSC_SERVO_X_TACHO_COUNTER_FAILURE	The X axis tacho counter failed to clear at power-on	System PWA	100%
2609	FSC_SERVO_Y_TACHO_COUNTER_FAILURE	The Y axis tacho counter failed to clear at power-on	System PWA	100%
260A	FSC_SERVO_THETA_TACHO_COUNTER_FAILURE	The Theta axis tacho counter failed to clear at power-on	Hand PWA System PWA	80% 20%

<b>FSC</b>	<b>Name</b>	<b>Description</b>	<b>FRU Name</b>	<b>Confidence %</b>
260B	FSC_SERVO_PICKER_TACHO_COUNTER_FAILURE	The Picker axis tacho counter failed to clear at power-on	Hand PWA System PWA	80% 20%
260C	FSC_SERVO_SHUTTLE_TACHO_COUNTER_FAILURE	The Shuttle axis tacho counter failed to clear at power-on	Hand PWA System PWA	80% 20%
260D	FSC_SERVO_Z_TACHO_COUNTER_FAILURE	The Z axis tacho counter failed to clear at power-on	Hand PWA System PWA	80% 20%
260E	FSC_SERVO_UNABLE_TO_MOVE_HAND	The hand could not be returned to the XY center during power-on		
260F	FSC_SERVO_INVALID_COMMAND_CODE_RECEIVED	The Servo task has received an invalid command code	Microcode	100%
2610	FSC_SERVO_FAILED_TO_GET_CARTRIDGE	The pick action 'completed' with no cartridge detected in the hand		
2611	FSC_SERVO_FAILED_TO_OFFLOAD_CARTRIDGE	The put action 'completed' with the cartridge still in the hand		
2612	FSC_SERVO_CARTRIDGE_IN_THE_HAND	Requested action can't be carried out with a cartridge in the hand		
2613	FSC_SERVO_NO_CARTRIDGE_IN_THE_HAND	Requested action can't be carried out without a cartridge in the hand		
2614	FSC_SERVO_AXIS_NOT_INITIALIZED	Command cannot be executed without first initializing the axis		

<b>FSC</b>	<b>Name</b>	<b>Description</b>	<b>FRU Name</b>	<b>Confidence %</b>
2615	FSC_SERVO_NVR_THETA_DATA_INVALID	Theta NVR data has been corrupted, or not yet initialized		
2616	FSC_SERVO_NVR_FRICTION_DATA_INVALID	Axis friction NVR data has been corrupted, or not yet initialized		
2617	FSC_SERVO_NVR_OFFSET_DATA_INVALID	Axis offset NVR data has been corrupted		
2618	FSC_SERVO_NVR_BUILD_DATA_INVALID	The build level NVR data has been corrupted, or not initialized		
2619	FSC_SERVO_NVR_DATA_INVALID	An error has been detected in the servo NVR		
261A	FSC_SERVO_SOURCE_EMPTY	The pick action 'completed' with no cartridge detected in the hand		
261B	FSC_SERVO_HAND_SENSOR_FAILURE	The pick action 'completed' with no cartridge detected in the hand		
261C	FSC_SERVO_PICKER_UNABLE_TO_ENGAGE	The pick action 'completed' with no cartridge detected in the hand		
261D	FSC_SERVO_PICKER_AXIS_JAMMED	The Picker will not move in either direction		
261E	FSC_SERVO_PICK_ACTION_STALLED	The Picker could not get the cartridge to its required position		

<b>FSC</b>	<b>Name</b>	<b>Description</b>	<b>FRU Name</b>	<b>Confidence %</b>
261F	FSC_SERVO_SHUTTLE_SENSOR_FAILURE	The box's shuttle sensor was not detected during shuttle calibration		
2620	FSC_SERVO_NVR_SHUTTLE_DATA_INVALID	Shuttle NVR data has been corrupted, or not yet initialized		
2621	FSC_SERVO_X_AXIS_JAMMED	The X axis cannot be moved properly in either direction		
2622	FSC_SERVO_FAILED_TO_RAISE_DRIVE_HUB	The drive hub could not be raised into position on cartridge load		
2623	FSC_SERVO_CARTRIDGE_STILL_LATCHED	The cartridge is still being retained by the drive		
2624	FSC_SERVO_CLEANER_SLOT_NOT_ACCESSIBLE	The (NVR spec'd) XY build does not provide access to the cleaner slot	XY NVR	50% 50%
2625	FSC_SERVO_SHUTTLE_NOT_CALIBRATED	The shuttle's vertical position is still unknown		
2626	FSC_SERVO_THETA_CALIBRATION_ERROR	The Theta angles are out of specification after calibration attempt		
2627	FSC_SERVO_X_CALIBRATION_ERROR	The X axis did not travel the minimum distance when calibrating		

Appendix B Fault Symptom Code (FSC) Dictionary

<b>FSC</b>	<b>Name</b>	<b>Description</b>	<b>FRU Name</b>	<b>Confidence %</b>
2628	FSC_SERVO_Y_CALIBRATION_ERROR	The Y axis did not travel the minimum distance when calibrating		
2629	FSC_SERVO_PICKER_JAM_RECOVERED	Picker jam occurring, being recovered, but retry now exhausted		
262A	FSC_SERVO_THETA_SENSOR_0_FAILURE	The Theta sensor closest to the RH magazine failed to switch		
262B	FSC_SERVO_THETA_SENSOR_1_FAILURE	The Theta sensor closest to the LH magazine failed to switch		
262C	FSC_SERVO_X_AXIS_SENSOR_FAILURE	The X axis sensor could not be detected changing state		
262D	FSC_SERVO_Y_AXIS_SENSOR_FAILURE	The Y axis sensor could not be detected changing state		
262E	FSC_SERVO_PICKER_CALIBRATION_ERROR	The Picker axis did not travel the minimum distance when calibrating		
262F	FSC_SERVO_X_FRICTION_TOO_HIGH	The X axis friction is too high for normal operation		
2630	FSC_SERVO_Y_FRICTION_TOO_HIGH	The Y axis friction is too high for normal operation		



<b>FSC</b>	<b>Name</b>	<b>Description</b>	<b>FRU Name</b>	<b>Confidence %</b>
2631	FSC_SERVO_THETA_FRICTION_TOO_HIGH	The Theta axis friction is too high for normal operation		
2632	FSC_SERVO_PICKER_FRICTION_TOO_HIGH	The Picker axis friction is too high for normal operation		
2633	FSC_SERVO_Z_CALIBRATION_ERROR	The Z axis did not travel the minimum distance when calibrating		
2634	FSC_SERVO_MAGAZINE_PARTIALLY_INSERTED	The inserted magazine has not been pushed fully home		
2635	FSC_SERVO_Z_FRICTION_TOO_HIGH	The Z axis friction is too high for normal operation		
2636	FSC_SERVO_SHUTTLE_CALIBRATION_ERROR	The shuttle's X axis offset is too great		
2637	FSC_SERVO_SHUTTLE_PICKER_CALIBRATION_ERROR	The shuttle is set too far back on the Picker axis		
2638	FSC_SERVO_GROSS_POSITION_ERROR	One of the axes has suffered a gross position error		
2639	FSC_SERVO_SLOT_CALIBRATION_ERROR	The cartridge position error detected on the Y axis is too great		
263A	FSC_SERVO_DRIVE_FXD_SLOT_CALIBRATION_ERROR	The cartridge position error detected on the X axis is too great		

<b>FSC</b>	<b>Name</b>	<b>Description</b>	<b>FRU Name</b>	<b>Confidence %</b>
263B	FSC_SERVO_CLEANING_TAPE_EXPIRED	The cleaning tape in use has expired		
263C	FSC_SERVO_NOT_CLEANING_TAPE	The auto-clean cycle has loaded a non-cleaning or invalid tape		
263D	FSC_SERVO_SHUTTLE_NOT_IN_POSITION	The shuttle has not been detected opposite the Picker during calibration		
263E	FSC_SERVO_CARTRIDGE_NOT_FULLY_HOME_IN_SHUTTLE	The cartridge is not fully in the shuttle, manual intervention required		
2680	FSC_SERVO_DRIVE_1_HARDWARE_ERROR	Drive 1 has reported a hardware error	Drive 1	100%
2681	FSC_SERVO_DRIVE_2_HARDWARE_ERROR	Drive 2 has reported a hardware error	Drive 2	100%
2682	FSC_SERVO_DRIVE_3_HARDWARE_ERROR	Drive 3 has reported a hardware error	Drive 3	100%
2683	FSC_SERVO_DRIVE_4_HARDWARE_ERROR	Drive 4 has reported a hardware error	Drive 4	100%
2684	FSC_SERVO_DRIVE_5_HARDWARE_ERROR	Drive 5 has reported a hardware error	Drive 5	100%
2685	FSC_SERVO_DRIVE_6_HARDWARE_ERROR	Drive 6 has reported a hardware error	Drive 6	100%
2686	FSC_SERVO_DRIVE_7_HARDWARE_ERROR	Drive 7 has reported a hardware error	Drive 7	100%
2687	FSC_SERVO_DRIVE_8_HARDWARE_ERROR	Drive 8 has reported a hardware error	Drive 8	100%

<b>FSC</b>	<b>Name</b>	<b>Description</b>	<b>FRU Name</b>	<b>Confidence %</b>
2688	FSC_SERVO_DRIVE_1_HANDLE_LOCKED_OUT	Drive 1 will not allow the handle to be operated as required	Drive 1	100%
2689	FSC_SERVO_DRIVE_2_HANDLE_LOCKED_OUT	Drive 2 will not allow the handle to be operated as required	Drive 2	100%
268A	FSC_SERVO_DRIVE_3_HANDLE_LOCKED_OUT	Drive 3 will not allow the handle to be operated as required	Drive 3	100%
268B	FSC_SERVO_DRIVE_4_HANDLE_LOCKED_OUT	Drive 4 will not allow the handle to be operated as required	Drive 4	100%
268C	FSC_SERVO_DRIVE_5_HANDLE_LOCKED_OUT	Drive 5 will not allow the handle to be operated as required	Drive 5	100%
268D	FSC_SERVO_DRIVE_6_HANDLE_LOCKED_OUT	Drive 6 will not allow the handle to be operated as required	Drive 6	100%
268E	FSC_SERVO_DRIVE_7_HANDLE_LOCKED_OUT	Drive 7 will not allow the handle to be operated as required	Drive 7	100%
268F	FSC_SERVO_DRIVE_8_HANDLE_LOCKED_OUT	Drive 8 will not allow the handle to be operated as required	Drive 8	100%
2690	FSC_SERVO_DRIVE_1_HANDLE_FAILED_TO_CLOSE	Drive 1 handle failed to close	Drive 1	100%
2691	FSC_SERVO_DRIVE_2_HANDLE_FAILED_TO_CLOSE	Drive 2 handle failed to close	Drive 2	100%

<b>FSC</b>	<b>Name</b>	<b>Description</b>	<b>FRU Name</b>	<b>Confidence %</b>
2692	FSC_SERVO_DRIVE_3_HANDLE_FAILED_TO_CLOSE	Drive 3 handle failed to close	Drive 3	100%
2693	FSC_SERVO_DRIVE_4_HANDLE_FAILED_TO_CLOSE	Drive 4 handle failed to close	Drive 4	100%
2694	FSC_SERVO_DRIVE_5_HANDLE_FAILED_TO_CLOSE	Drive 5 handle failed to close	Drive 5	100%
2695	FSC_SERVO_DRIVE_6_HANDLE_FAILED_TO_CLOSE	Drive 6 handle failed to close	Drive 6	100%
2696	FSC_SERVO_DRIVE_7_HANDLE_FAILED_TO_CLOSE	Drive 7 handle failed to close	Drive 7	100%
2697	FSC_SERVO_DRIVE_8_HANDLE_FAILED_TO_CLOSE	Drive 8 handle failed to close	Drive 8	100%
2698	FSC_SERVO_DRIVE_1_HANDLE_FAILED_TO_OPEN	Drive 1 handle failed to open	Drive 1	100%
2699	FSC_SERVO_DRIVE_2_HANDLE_FAILED_TO_OPEN	Drive 2 handle failed to open	Drive 2	100%
269A	FSC_SERVO_DRIVE_3_HANDLE_FAILED_TO_OPEN	Drive 3 handle failed to open	Drive 3	100%
269B	FSC_SERVO_DRIVE_4_HANDLE_FAILED_TO_OPEN	Drive 4 handle failed to open	Drive 4	100%

<b>FSC</b>	<b>Name</b>	<b>Description</b>	<b>FRU Name</b>	<b>Confidence %</b>
269C	FSC_SERVO_DRIVE_5_HANDLE_FAILED_TO_OPEN	Drive 5 handle failed to open	Drive 5	100%
269D	FSC_SERVO_DRIVE_6_HANDLE_FAILED_TO_OPEN	Drive 6 handle failed to open	Drive 6	100%
269E	FSC_SERVO_DRIVE_7_HANDLE_FAILED_TO_OPEN	Drive 7 handle failed to open	Drive 7	100%
269F	FSC_SERVO_DRIVE_8_HANDLE_FAILED_TO_OPEN	Drive 8 handle failed to open	Drive 8	100%
26A0	FSC_SERVO_DRIVE_1_IN_FLUX	Drive 1 is indicating 'in flux', i.e. not ready for commands	Drive 1	100%
26A1	FSC_SERVO_DRIVE_2_IN_FLUX	Drive 2 is indicating 'in flux', i.e. not ready for commands	Drive 2	100%
26A2	FSC_SERVO_DRIVE_3_IN_FLUX	Drive 3 is indicating 'in flux', i.e. not ready for commands	Drive 3	100%
26A3	FSC_SERVO_DRIVE_4_IN_FLUX	Drive 4 is indicating 'in flux', i.e. not ready for commands	Drive 4	100%
26A4	FSC_SERVO_DRIVE_5_IN_FLUX	Drive 5 is indicating 'in flux', i.e. not ready for commands	Drive 5	100%
26A5	FSC_SERVO_DRIVE_6_IN_FLUX	Drive 6 is indicating 'in flux', i.e. not ready for commands	Drive 6	100%

<b>FSC</b>	<b>Name</b>	<b>Description</b>	<b>FRU Name</b>	<b>Confidence %</b>
26A6	FSC_SERVO_DRIVE_7_IN_FLUX	Drive 7 is indicating 'in flux', i.e. not ready for commands	Drive 7	100%
26A7	FSC_SERVO_DRIVE_8_IN_FLUX	Drive 8 is indicating 'in flux', i.e. not ready for commands	Drive 8	100%
26A8	FSC_SERVO_DRIVE_1_HANDLE_CLOSED_MISMATCH	Drive 1 is indicating its handle is closed, should have been open	Drive 1 Microcode	50% 50%
26A9	FSC_SERVO_DRIVE_2_HANDLE_CLOSED_MISMATCH	Drive 2 is indicating its handle is closed, should have been open	Drive 2 Microcode	50% 50%
26AA	FSC_SERVO_DRIVE_3_HANDLE_CLOSED_MISMATCH	Drive 3 is indicating its handle is closed, should have been open	Drive 3 Microcode	50% 50%
26AB	FSC_SERVO_DRIVE_4_HANDLE_CLOSED_MISMATCH	Drive 4 is indicating its handle is closed, should have been open	Drive 4 Microcode	50% 50%
26AC	FSC_SERVO_DRIVE_5_HANDLE_CLOSED_MISMATCH	Drive 5 is indicating its handle is closed, should have been open	Drive 5 Microcode	50% 50%
26AD	FSC_SERVO_DRIVE_6_HANDLE_CLOSED_MISMATCH	Drive 6 is indicating its handle is closed, should have been open	Drive 6 Microcode	50% 50%
26AE	FSC_SERVO_DRIVE_7_HANDLE_CLOSED_MISMATCH	Drive 7 is indicating its handle is closed, should have been open	Drive 7 Microcode	50% 50%
26AF	FSC_SERVO_DRIVE_8_HANDLE_CLOSED_MISMATCH	Drive 8 is indicating its handle is closed, should have been open	Drive 8 Microcode	50% 50%

<b>FSC</b>	<b>Name</b>	<b>Description</b>	<b>FRU Name</b>	<b>Confidence %</b>
26B0	FSC_SERVO_DRIVE_1_HANDLE_OPEN_MISMATCH	Drive 1 is indicating its handle is open, should have been closed	Drive 1 Microcode	50% 50%
26B1	FSC_SERVO_DRIVE_2_HANDLE_OPEN_MISMATCH	Drive 2 is indicating its handle is open, should have been closed	Drive 2 Microcode	50% 50%
26B2	FSC_SERVO_DRIVE_3_HANDLE_OPEN_MISMATCH	Drive 3 is indicating its handle is open, should have been closed	Drive 3 Microcode	50% 50%
26B3	FSC_SERVO_DRIVE_4_HANDLE_OPEN_MISMATCH	Drive 4 is indicating its handle is open, should have been closed	Drive 4 Microcode	50% 50%
26B4	FSC_SERVO_DRIVE_5_HANDLE_OPEN_MISMATCH	Drive 5 is indicating its handle is open, should have been closed	Drive 5 Microcode	50% 50%
26B5	FSC_SERVO_DRIVE_6_HANDLE_OPEN_MISMATCH	Drive 6 is indicating its handle is open, should have been closed	Drive 6 Microcode	50% 50%
26B6	FSC_SERVO_DRIVE_7_HANDLE_OPEN_MISMATCH	Drive 7 is indicating its handle is open, should have been closed	Drive 7 Microcode	50% 50%
26B7	FSC_SERVO_DRIVE_8_HANDLE_OPEN_MISMATCH	Drive 8 is indicating its handle is open, should have been closed	Drive 8 Microcode	50% 50%
26B8	FSC_SERVO_DRIVE_1_HAS_NO_CARTRIDGE	Drive 1 has no cartridge to unload	Drive 1 Microcode	50% 50%
26B9	FSC_SERVO_DRIVE_2_HAS_NO_CARTRIDGE	Drive 2 has no cartridge to unload	Drive 2 Microcode	50% 50%
26BA	FSC_SERVO_DRIVE_3_HAS_NO_CARTRIDGE	Drive 3 has no cartridge to unload	Drive 3 Microcode	50% 50%

<b>FSC</b>	<b>Name</b>	<b>Description</b>	<b>FRU Name</b>	<b>Confidence %</b>
26BB	FSC_SERVO_DRIVE_4_ HAS_NO_CARTRIDGE	Drive 4 has no cartridge to unload	Drive 4 Microcode	50% 50%
26BC	FSC_SERVO_DRIVE_5_ HAS_NO_CARTRIDGE	Drive 5 has no cartridge to unload	Drive 5 Microcode	50% 50%
26BD	FSC_SERVO_DRIVE_6_ HAS_NO_CARTRIDGE	Drive 6 has no cartridge to unload	Drive 6 Microcode	50% 50%
26BE	FSC_SERVO_DRIVE_7_ HAS_NO_CARTRIDGE	Drive 7 has no cartridge to unload	Drive 7 Microcode	50% 50%
26BF	FSC_SERVO_DRIVE_8_ HAS_NO_CARTRIDGE	Drive 8 has no cartridge to unload	Drive 8 Microcode	50% 50%
26C0	FSC_SERVO_DRIVE_1_ HAS_NOT_ RESPONDED_TO_ UNLOAD	Drive 1 has not responded to multiple requests to unload	Drive 1 Microcode	50% 50%
26C1	FSC_SERVO_DRIVE_2_ HAS_NOT_ RESPONDED_TO_ UNLOAD	Drive 2 has not responded to multiple requests to unload	Drive 2 Microcode	50% 50%
26C2	FSC_SERVO_DRIVE_3_ HAS_NOT_ RESPONDED_TO_ UNLOAD	Drive 3 has not responded to multiple requests to unload	Drive 3 Microcode	50% 50%
26C3	FSC_SERVO_DRIVE_4_ HAS_NOT_ RESPONDED_TO_ UNLOAD	Drive 4 has not responded to multiple requests to unload	Drive 4 Microcode	50% 50%
26C4	FSC_SERVO_DRIVE_5_ HAS_NOT_ RESPONDED_TO_ UNLOAD	Drive 5 has not responded to multiple requests to unload	Drive 5 Microcode	50% 50%



<b>FSC</b>	<b>Name</b>	<b>Description</b>	<b>FRU Name</b>	<b>Confidence %</b>
26C5	FSC_SERVO_DRIVE_6_ HAS_NOT_ RESPONDED_TO_ UNLOAD	Drive 6 has not responded to multiple requests to unload	Drive 6 Microcode	50% 50%
26C6	FSC_SERVO_DRIVE_7_ HAS_NOT_ RESPONDED_TO_ UNLOAD	Drive 7 has not responded to multiple requests to unload	Drive 7 Microcode	50% 50%
26C7	FSC_SERVO_DRIVE_8_ HAS_NOT_ RESPONDED_TO_ UNLOAD	Drive 8 has not responded to multiple requests to unload	Drive 8 Microcode	50% 50%
26C8	FSC_SERVO_DRIVE_1_ HAS_REJECTED_THE_ CARTRIDGE	Drive 1 has rejected the cartridge, cannot be loaded	Drive 1 Microcode	50% 50%
26C9	FSC_SERVO_DRIVE_2_ HAS_REJECTED_THE_ CARTRIDGE	Drive 2 has rejected the cartridge, cannot be loaded	Drive 2 Microcode	50% 50%
26CA	FSC_SERVO_DRIVE_3_ HAS_REJECTED_THE_ CARTRIDGE	Drive 3 has rejected the cartridge, cannot be loaded	Drive 3 Microcode	50% 50%
26CB	FSC_SERVO_DRIVE_4_ HAS_REJECTED_THE_ CARTRIDGE	Drive 4 has rejected the cartridge, cannot be loaded	Drive 4 Microcode	50% 50%
26CC	FSC_SERVO_DRIVE_5_ HAS_REJECTED_THE_ CARTRIDGE	Drive 5 has rejected the cartridge, cannot be loaded	Drive 5 Microcode	50% 50%
26CD	FSC_SERVO_DRIVE_6_ HAS_REJECTED_THE_ CARTRIDGE	Drive 6 has rejected the cartridge, cannot be loaded	Drive 6 Microcode	50% 50%
26CE	FSC_SERVO_DRIVE_7_ HAS_REJECTED_THE_ CARTRIDGE	Drive 7 has rejected the cartridge, cannot be loaded	Drive 7 Microcode	50% 50%

<b>FSC</b>	<b>Name</b>	<b>Description</b>	<b>FRU Name</b>	<b>Confidence %</b>
26CF	FSC_SERVO_DRIVE_8_ HAS_REJECTED_THE_ CARTRIDGE	Drive 8 has rejected the cartridge, cannot be loaded	Drive 8 Microcode	50% 50%
26D0	FSC_SERVO_DRIVE_1_ HAS_FAILED_TO_LOAD	Drive 1 has failed to load the tape successfully	Drive 1 Microcode	50% 50%
26D1	FSC_SERVO_DRIVE_2_ HAS_FAILED_TO_LOAD	Drive 2 has failed to load the tape successfully	Drive 2 Microcode	50% 50%
26D2	FSC_SERVO_DRIVE_3_ HAS_FAILED_TO_LOAD	Drive 3 has failed to load the tape successfully	Drive 3 Microcode	50% 50%
26D3	FSC_SERVO_DRIVE_4_ HAS_FAILED_TO_LOAD	Drive 4 has failed to load the tape successfully	Drive 4 Microcode	50% 50%
26D4	FSC_SERVO_DRIVE_5_ HAS_FAILED_TO_LOAD	Drive 5 has failed to load the tape successfully	Drive 5 Microcode	50% 50%
26D5	FSC_SERVO_DRIVE_6_ HAS_FAILED_TO_LOAD	Drive 6 has failed to load the tape successfully	Drive 6 Microcode	50% 50%
26D6	FSC_SERVO_DRIVE_7_ HAS_FAILED_TO_LOAD	Drive 7 has failed to load the tape successfully	Drive 7 Microcode	50% 50%
26D7	FSC_SERVO_DRIVE_8_ HAS_FAILED_TO_LOAD	Drive 8 has failed to load the tape successfully	Drive 8 Microcode	50% 50%
26D8	FSC_SERVO_DRIVE_1_ ACCESSED_WHEN_ NOT_FITTED	Attempt to initialize Drive 1 before it has become available	Drive 1 Microcode	50% 50%

<b>FSC</b>	<b>Name</b>	<b>Description</b>	<b>FRU Name</b>	<b>Confidence %</b>
26D9	FSC_SERVO_DRIVE_2_ ACCESSED_WHEN_ NOT_FITTED	Attempt to initialize Drive 2 before it has become available	Drive 2  Microcode	50%  50%
26DA	FSC_SERVO_DRIVE_3_ ACCESSED_WHEN_ NOT_FITTED	Attempt to initialize Drive 3 before it has become available	Drive 3  Microcode	50%  50%
26DB	FSC_SERVO_DRIVE_4_ ACCESSED_WHEN_ NOT_FITTED	Attempt to initialize Drive 4 before it has become available	Drive 4  Microcode	50%  50%
26DC	FSC_SERVO_DRIVE_5_ ACCESSED_WHEN_ NOT_FITTED	Attempt to initialize Drive 5 before it has become available	Drive 5  Microcode	50%  50%
26DD	FSC_SERVO_DRIVE_6_ ACCESSED_WHEN_ NOT_FITTED	Attempt to initialize Drive 6 before it has become available	Drive 6  Microcode	50%  50%
26DE	FSC_SERVO_DRIVE_7_ ACCESSED_WHEN_ NOT_FITTED	Attempt to initialize Drive 7 before it has become available	Drive 7  Microcode	50%  50%
26DF	FSC_SERVO_DRIVE_8_ ACCESSED_WHEN_ NOT_FITTED	Attempt to initialize Drive 8 before it has become available	Drive 8  Microcode	50%  50%
2700	FSC_DIAG_NO_ RESOURCE	PCDIAG task initialization failed	Microcode	100%
2701	FSC_DIAG_BAD_ MESSAGE	Unknown or bad diagnostic message		
2702	FSC_DIAG_STACK_ TERMINATED	Current diagnostic stack has terminated		
2703	FSC_DIAG_QUEUE_ FULL	PCDIAG queue full	Microcode	100%

<b>FSC</b>	<b>Name</b>	<b>Description</b>	<b>FRU Name</b>	<b>Confidence %</b>
2704	FSC_DIAG_EMPTY_INITIATOR_LIST	Diagnostic command failure; initiator task unknown	Microcode	100%
2800	FSC_EVENT_NO_RESOURCE	EVENT LOG task initialization failed	Microcode	100%
2801	FSC_EVENT_NVR_TOO_SMALL	NVR space allocated to event log is too small. See path for required space and change in system.	Microcode	100%
2802	FSC_EVENT_BAD_RETRY_LEVEL	Event logger received bad retry level definition	Microcode	100%
2803	FSC_EVENT_BAD_MAGIC	Magic number in event log is bad (log corrupted?)	Microcode	100%
2900	FSC_STACK_CONTROL_NO_RESOURCE	Stack Controller task initialization failed	Microcode	100%
2901	FSC_STACK_CONTROL_QUEUE_FULL	Stack Controller queue is full	Microcode	100%
2902	FSC_STACK_CONTROL_BAD_MESSAGE	Stack Controller task received an unknown or unexpected message		
2A00	FSC_SHUTTLE_QUEUE_FULL	Shuttle queue is full	Microcode	100%
4000	INFO_SCSI_INVALID_LUN	SCSI command received for invalid LUN	Status only	100%
4001	INFO_SCSI_UNKNOWN_ASC	An ASC/ASCQ was used without updating error log logging	Status only	100%

<b>FSC</b>	<b>Name</b>	<b>Description</b>	<b>FRU Name</b>	<b>Confidence %</b>
4002	INFO_SCSI_ILLEGAL_COMMAND	Illegal SCSI command received	Status only	100%
4003	INFO_SCSI_TARGET_BUSY	Command received, but library is busy	Status only	100%
4004	INFO_SCSI_DEFERRED_ERROR	Deferred error is pending	Status only	100%
4005	INFO_SCSI_ATTENTION_RESET	Unit attention - due to reset	Status only	100%
4006	INFO_SCSI_ATTENTION_MODE_PARAMS	Unit attention - due to mode parameters changed	Status only	100%
4007	INFO_SCSI_ATTENTION_MEDIUM_CHANGE	Unit attention - due to medium changed	Status only	100%
4008	INFO_SCSI_INVALID_FIELD_IN_CDB	SCSI command had invalid field in CDB	Status only	100%
4009	INFO_SCSI_PARAMETER_LIST_LENGTH_ERROR	SCSI command had parameter list length error	Status only	100%
400A	INFO_SCSI_INVALID_FIELD_IN_PARAMETER_LIST	SCSI command had invalid field in parameter list	Status only	100%
400B	INFO_SCSI_PARAMETER_VALUE_INVALID	SCSI command had invalid parameter value	Status only	100%
400C	INFO_SCSI_MECHANICAL_ERROR	SCSI command failed due to servo problem	Status only	100%
400D	INFO_SCSI_NO_SENSE	No sense available	Status only	100%
400E	INFO_SCSI_CLEANER_CARTRIDGE	Cleaner cartridge fitted	Status only	100%

<b>FSC</b>	<b>Name</b>	<b>Description</b>	<b>FRU Name</b>	<b>Confidence %</b>
400F	INFO_SCSI_MEDIUM_DESTINATION_ELEMENT_FULL	Move medium destination full	Status only	100%
4010	INFO_SCSI_MEDIUM_SOURCE_ELEMENT_EMPTY	Move medium source empty	Status only	100%
4011	INFO_SCSI_SAVING_PARAMETERS_NOT_SUPPORTED	Saving parameters is not supported	Status only	100%
4012	INFO_SCSI_BAD_ELEMENT	Illegal element number	Status only	100%
4013	INFO_SCSI_CARTRIDGE_IN_HAND	Can't complete command while cartridge in hand	Status only	100%
4014	INFO_SCSI_LOGICAL_UNIT_HAS_NOT_SELF_CONFIGURED_YET	Power on configuration not yet finished	Status only	100%
4015	INFO_SCSI_LOGICAL_UNIT_IS_IN_PROCESS_OF_BECOMING_READY	Library will be ready soon, check back later	Status only	100%
4016	INFO_SCSI_LOGICAL_UNIT_NOT_READY_CAUSE_NOT_REPORTABLE	Library not ready, reason unknown	Status only	100%
4017	INFO_SCSI_DOOR_OPEN	Door is open	Status only	100%
4018	INFO_SCSI_IMPORT_EXPORT_OPEN	Import export is open	Status only	100%
4019	INFO_SCSI_IN_MENU	Operator panel is in menu mode	Status only	100%

<b>FSC</b>	<b>Name</b>	<b>Description</b>	<b>FRU Name</b>	<b>Confidence %</b>
401A	INFO_SCSI_IMPORT_OR_EXPORT_ELEMENT_ACCESSED	Import/export has been accessed	Status only	100%
401B	INFO_SCSI_RESERVATION_CONFLICT	Command failed due to reservation conflict	Status only	100%
401C	INFO_SCSI_BUS_RESET	SCSI bus reset received	Status only	100%
401D	INFO_SCSI_BUS_DEVICE_RESET	SCSI bus device reset message received	Status only	100%
401E	INFO_SCSI_ABORT	SCSI abort message received	Status only	100%
401F	INFO_SCSI_MESSAGE_PARITY_ERROR	SCSI message parity error received	Status only	100%
4020	INFO_SCSI_INITIATOR_DETECTED_ERROR	SCSI initiator detected error received	Status only	100%
4100	INFO_PCDIAG_TIME_SET	Time was set via serial port	Status only	100%
4101	INFO_PCDIAG_REMOTE_TIME_SYNC	Time set via synchronization command	Status only	100%
4102	INFO_PCDIAG_TIME_SYNC	Synchronize clock command issued	Status only	100%
4103	INFO_PCDIAG_REBOOT	Library is rebooting	Status only	100%
4104	INFO_PCDIAG_ENTER_BOOT	Library entering boot mode	Status only	100%
4105	INFO_PCDIAG_STARTED	Library has just started	Status only	100%

<b>FSC</b>	<b>Name</b>	<b>Description</b>	<b>FRU Name</b>	<b>Confidence %</b>
4106	INFO_PCDIAG_REMOTE_ACK_TIMEOUT	Time out waiting for remote ACK	Status only	100%
4107	INFO_PCDIAG_REMOTE_RESPONSE_TIMEOUT	Time out waiting for remote RESPONSE	Status only	100%
4108	INFO_PCDIAG_RECVD_REMOTE_TIMEOUT	Remote machine sent time out message	Status only	100%
4200	INFO_SYSTEM_NVR_CORRUPT	NVR CRC invalid, contents probably corrupt	Status only	100%
4400	INFO_LIBRARIAN_ROBOT_PAUSED	Robot paused for operator safety (robotics accessible by operator)	Status only	100%
4401	INFO_LIBRARIAN_DOOR_1_OPEN	Door 1 open (left door)	Status only	100%
4402	INFO_LIBRARIAN_DOOR_2_OPEN	Door 2 open (right door)	Status only	100%
4405	INFO_LIBRARIAN_DOOR_1_CLOSED	Door 1 closed (left door)	Status only	100%
4406	INFO_LIBRARIAN_DOOR_2_CLOSED	Door 2 closed (right door)	Status only	100%
4407	INFO_LIBRARIAN_DOOR_3_CLOSED	Door 3 closed	Status only	100%
4408	INFO_LIBRARIAN_DOOR_4_CLOSED	Door 4 closed	Status only	100%
4409	INFO_LIBRARIAN_MAG_1_REMOVED	Magazine 1 has been removed (left magazine)	Status only	100%



<b>FSC</b>	<b>Name</b>	<b>Description</b>	<b>FRU Name</b>	<b>Confidence %</b>
440A	INFO_LIBRARIAN_MAG_2_REMOVED	Magazine 2 has been removed (right magazine)	Status only	100%
440B	INFO_LIBRARIAN_MAG_3_REMOVED	Magazine 3 has been removed (left magazine)	Status only	100%
440C	INFO_LIBRARIAN_MAG_4_REMOVED	Magazine 4 has been removed (right magazine)	Status only	100%
440D	INFO_LIBRARIAN_MAG_5_REMOVED	Magazine 5 has been removed (left magazine)	Status only	100%
440E	INFO_LIBRARIAN_MAG_6_REMOVED	Magazine 6 has been removed (right magazine)	Status only	100%
440F	INFO_LIBRARIAN_MAG_7_REMOVED	Magazine 7 has been removed (left magazine)	Status only	100%
4410	INFO_LIBRARIAN_MAG_8_REMOVED	Magazine 8 has been removed (right magazine)	Status only	100%
4411	INFO_LIBRARIAN_MAG_9_REMOVED	Magazine 9 has been removed (left magazine)	Status only	100%
4412	INFO_LIBRARIAN_MAG_10_REMOVED	Magazine 10 has been removed (right magazine)	Status only	100%
4413	INFO_LIBRARIAN_MAG_1_INSERTED	Magazine 1 has been inserted (left magazine)	Status only	100%

<b>FSC</b>	<b>Name</b>	<b>Description</b>	<b>FRU Name</b>	<b>Confidence %</b>
4414	INFO_LIBRARIAN_MAG_2_INSERTED	Magazine 2 has been inserted (right magazine)	Status only	100%
4415	INFO_LIBRARIAN_MAG_3_INSERTED	Magazine 3 has been inserted (left magazine)	Status only	100%
4416	INFO_LIBRARIAN_MAG_4_INSERTED	Magazine 4 has been inserted (left magazine)	Status only	100%
4417	INFO_LIBRARIAN_MAG_5_INSERTED	Magazine 5 has been inserted (left magazine)	Status only	100%
4418	INFO_LIBRARIAN_MAG_6_INSERTED	Magazine 6 has been inserted (left magazine)	Status only	100%
4419	INFO_LIBRARIAN_MAG_7_INSERTED	Magazine 7 has been inserted (left magazine)	Status only	100%
441A	INFO_LIBRARIAN_MAG_8_INSERTED	Magazine 8 has been inserted (left magazine)	Status only	100%
441B	INFO_LIBRARIAN_MAG_9_INSERTED	Magazine 9 has been inserted (left magazine)	Status only	100%
441C	INFO_LIBRARIAN_MAG_10_INSERTED	Magazine 10 has been inserted (left magazine)	Status only	100%
441D	INFO_LIBRARIAN_MAG_1_ABSENT	Magazine 1 absent at power-up (left magazine)	Status only	100%

<b>FSC</b>	<b>Name</b>	<b>Description</b>	<b>FRU Name</b>	<b>Confidence %</b>
441E	INFO_LIBRARIAN_MAG_2_ABSENT	Magazine 2 absent at power-up (right magazine)	Status only	100%
441F	INFO_LIBRARIAN_MAG_3_ABSENT	Magazine 3 absent at power-up (left magazine)	Status only	100%
4420	INFO_LIBRARIAN_MAG_4_ABSENT	Magazine 4 absent at power-up (left magazine)	Status only	100%
4421	INFO_LIBRARIAN_MAG_5_ABSENT	Magazine 5 absent at power-up (left magazine)	Status only	100%
4422	INFO_LIBRARIAN_MAG_6_ABSENT	Magazine 6 absent at power-up (left magazine)	Status only	100%
4423	INFO_LIBRARIAN_MAG_7_ABSENT	Magazine 7 absent at power-up (left magazine)	Status only	100%
4424	INFO_LIBRARIAN_MAG_8_ABSENT	Magazine 8 absent at power-up (left magazine)	Status only	100%
4425	INFO_LIBRARIAN_MAG_9_ABSENT	Magazine 9 absent at power-up (left magazine)	Status only	100%
4426	INFO_LIBRARIAN_MAG_10_ABSENT	Magazine 10 absent at power-up (left magazine)	Status only	100%
4427	INFO_LIBRARIAN_READY	Library Ready	Status only	100%
4428	INFO_LIBRARIAN_NOT_READY	Library Not-Ready	Status only	100%

<b>FSC</b>	<b>Name</b>	<b>Description</b>	<b>FRU Name</b>	<b>Confidence %</b>
4429	INFO_LIBRARIAN_DRIVE_1_REMOVED	Drive 1 removed	Status only	100%
442A	INFO_LIBRARIAN_DRIVE_2_REMOVED	Drive 2 removed	Status only	100%
442B	INFO_LIBRARIAN_DRIVE_3_REMOVED	Drive 3 removed	Status only	100%
442C	INFO_LIBRARIAN_DRIVE_4_REMOVED	Drive 4 removed	Status only	100%
442D	INFO_LIBRARIAN_DRIVE_5_REMOVED	Drive 5 removed	Status only	100%
442E	INFO_LIBRARIAN_DRIVE_6_REMOVED	Drive 6 removed	Status only	100%
442F	INFO_LIBRARIAN_DRIVE_7_REMOVED	Drive 7 removed	Status only	100%
4430	INFO_LIBRARIAN_DRIVE_8_REMOVED	Drive 8 removed	Status only	100%
4434	INFO_LIBRARIAN_DRIVE_1_INSERTED	Drive 1 inserted	Status only	100%
4435	INFO_LIBRARIAN_DRIVE_2_INSERTED	Drive 2 inserted	Status only	100%
4436	INFO_LIBRARIAN_DRIVE_3_INSERTED	Drive 3 inserted	Status only	100%
4437	INFO_LIBRARIAN_DRIVE_4_INSERTED	Drive 4 inserted	Status only	100%
4438	INFO_LIBRARIAN_DRIVE_5_INSERTED	Drive 5 inserted	Status only	100%
4439	INFO_LIBRARIAN_DRIVE_6_INSERTED	Drive 6 inserted	Status only	100%

<b>FSC</b>	<b>Name</b>	<b>Description</b>	<b>FRU Name</b>	<b>Confidence %</b>
443A	INFO_LIBRARIAN_DRIVE_7_INSERTED	Drive 7 inserted	Status only	100%
443B	INFO_LIBRARIAN_DRIVE_8_INSERTED	Drive 8 inserted	Status only	100%
443E	INFO_LIBRARIAN_DRIVE_1_ABSENT	Drive 1 absent at power-on	Status only	100%
443F	INFO_LIBRARIAN_DRIVE_2_ABSENT	Drive 2 absent at power-on	Status only	100%
4440	INFO_LIBRARIAN_DRIVE_3_ABSENT	Drive 3 absent at power-on	Status only	100%
4441	INFO_LIBRARIAN_DRIVE_4_ABSENT	Drive 4 absent at power-on	Status only	100%
4442	INFO_LIBRARIAN_DRIVE_5_ABSENT	Drive 5 absent at power-on	Status only	100%
4443	INFO_LIBRARIAN_DRIVE_6_ABSENT	Drive 6 absent at power-on	Status only	100%
4444	INFO_LIBRARIAN_DRIVE_7_ABSENT	Drive 7 absent at power-on	Status only	100%
4445	INFO_LIBRARIAN_DRIVE_8_ABSENT	Drive 8 absent at power-on	Status only	100%
4448	INFO_LIBRARIAN_DRIVE_1_ON	Drive 1 has powered up	Status only	100%
4449	INFO_LIBRARIAN_DRIVE_2_ON	Drive 2 has powered up	Status only	100%
444A	INFO_LIBRARIAN_DRIVE_3_ON	Drive 3 has powered up	Status only	100%
444B	INFO_LIBRARIAN_DRIVE_4_ON	Drive 4 has powered up	Status only	100%

Appendix B Fault Symptom Code (FSC) Dictionary

<b>FSC</b>	<b>Name</b>	<b>Description</b>	<b>FRU Name</b>	<b>Confidence %</b>
444C	INFO_LIBRARIAN_DRIVE_5_ON	Drive 5 has powered up	Status only	100%
444D	INFO_LIBRARIAN_DRIVE_6_ON	Drive 6 has powered up	Status only	100%
444E	INFO_LIBRARIAN_DRIVE_7_ON	Drive 7 has powered up	Status only	100%
444F	INFO_LIBRARIAN_DRIVE_8_ON	Drive 8 has powered up	Status only	100%
4452	INFO_LIBRARIAN_DRIVE_1_OFF	Drive 1 has powered down	Status only	100%
4453	INFO_LIBRARIAN_DRIVE_2_OFF	Drive 2 has powered down	Status only	100%
4454	INFO_LIBRARIAN_DRIVE_3_OFF	Drive 3 has powered down	Status only	100%
4455	INFO_LIBRARIAN_DRIVE_4_OFF	Drive 4 has powered down	Status only	100%
4456	INFO_LIBRARIAN_DRIVE_5_OFF	Drive 5 has powered down	Status only	100%
4457	INFO_LIBRARIAN_DRIVE_6_OFF	Drive 6 has powered down	Status only	100%
4458	INFO_LIBRARIAN_DRIVE_7_OFF	Drive 7 has powered down	Status only	100%
4459	INFO_LIBRARIAN_DRIVE_8_OFF	Drive 8 has powered down	Status only	100%
445C	INFO_LIBRARIAN_DRIVE_1_AUTO_CLEAN_REQ	Drive 1 requesting auto-clean	Status only	100%

<b>FSC</b>	<b>Name</b>	<b>Description</b>	<b>FRU Name</b>	<b>Confidence %</b>
445D	INFO_LIBRARIAN_ DRIVE_2_AUTO_ CLEAN_REQ	Drive 2 requesting auto-clean	Status only	100%
445E	INFO_LIBRARIAN_ DRIVE_3_AUTO_ CLEAN_REQ	Drive 3 requesting auto-clean	Status only	100%
445F	INFO_LIBRARIAN_ DRIVE_4_AUTO_ CLEAN_REQ	Drive 4 requesting auto-clean	Status only	100%
4460	INFO_LIBRARIAN_ DRIVE_5_AUTO_ CLEAN_REQ	Drive 5 requesting auto-clean	Status only	100%
4461	INFO_LIBRARIAN_ DRIVE_6_AUTO_ CLEAN_REQ	Drive 6 requesting auto-clean	Status only	100%
4462	INFO_LIBRARIAN_ DRIVE_7_AUTO_ CLEAN_REQ	Drive 7 requesting auto-clean	Status only	100%
4463	INFO_LIBRARIAN_ DRIVE_8_AUTO_ CLEAN_REQ	Drive 8 requesting auto-clean	Status only	100%
4466	INFO_LIBRARIAN_ CLEAN_DRIVE_1	Cleaning cycle started on Drive 1	Status only	100%
4467	INFO_LIBRARIAN_ CLEAN_DRIVE_2	Cleaning cycle started on Drive 2	Status only	100%
4468	INFO_LIBRARIAN_ CLEAN_DRIVE_3	Cleaning cycle started on Drive 3	Status only	100%
4469	INFO_LIBRARIAN_ CLEAN_DRIVE_4	Cleaning cycle started on Drive 4	Status only	100%
446A	INFO_LIBRARIAN_ CLEAN_DRIVE_5	Cleaning cycle started on Drive 5	Status only	100%

<b>FSC</b>	<b>Name</b>	<b>Description</b>	<b>FRU Name</b>	<b>Confidence %</b>
446B	INFO_LIBRARIAN_CLEAN_DRIVE_6	Cleaning cycle started on Drive 6	Status only	100%
446C	INFO_LIBRARIAN_CLEAN_DRIVE_7	Cleaning cycle started on Drive 7	Status only	100%
446D	INFO_LIBRARIAN_CLEAN_DRIVE_8	Cleaning cycle started on Drive 8	Status only	100%
4470	INFO_LIBRARIAN_CLEANING_TAPE_EXPIRED	Cleaning tape expired	Status only	100%
4471	INFO_LIBRARIAN_NOT_CLEANING_TAPE	Drive clean attempted with a non-cleaning tape	Status only	100%
4472	INFO_LIBRARIAN_DRIVE_1_CLEAN_COMPLETE	Drive 1 has been cleaned successfully	Status only	100%
4473	INFO_LIBRARIAN_DRIVE_2_CLEAN_COMPLETE	Drive 2 has been cleaned successfully	Status only	100%
4474	INFO_LIBRARIAN_DRIVE_3_CLEAN_COMPLETE	Drive 3 has been cleaned successfully	Status only	100%
4475	INFO_LIBRARIAN_DRIVE_4_CLEAN_COMPLETE	Drive 4 has been cleaned successfully	Status only	100%
4476	INFO_LIBRARIAN_DRIVE_5_CLEAN_COMPLETE	Drive 5 has been cleaned successfully	Status only	100%
4477	INFO_LIBRARIAN_DRIVE_6_CLEAN_COMPLETE	Drive 6 has been cleaned successfully	Status only	100%



<b>FSC</b>	<b>Name</b>	<b>Description</b>	<b>FRU Name</b>	<b>Confidence %</b>
4478	INFO_LIBRARIAN_DRIVE_7_CLEAN_COMPLETE	Drive 7 has been cleaned successfully	Status only	100%
4479	INFO_LIBRARIAN_DRIVE_8_CLEAN_COMPLETE	Drive 8 has been cleaned successfully	Status only	100%
447C	INFO_LIBRARIAN_DRIVE_1_CLEAN_UNSUCCESSFUL	Drive 1 is still requesting cleaning after being cleaned	Status only	100%
447D	INFO_LIBRARIAN_DRIVE_2_CLEAN_UNSUCCESSFUL	Drive 2 is still requesting cleaning after being cleaned	Status only	100%
447E	INFO_LIBRARIAN_DRIVE_3_CLEAN_UNSUCCESSFUL	Drive 3 is still requesting cleaning after being cleaned	Status only	100%
447F	INFO_LIBRARIAN_DRIVE_4_CLEAN_UNSUCCESSFUL	Drive 4 is still requesting cleaning after being cleaned	Status only	100%
4480	INFO_LIBRARIAN_DRIVE_5_CLEAN_UNSUCCESSFUL	Drive 5 is still requesting cleaning after being cleaned	Status only	100%
4481	INFO_LIBRARIAN_DRIVE_6_CLEAN_UNSUCCESSFUL	Drive 6 is still requesting cleaning after being cleaned	Status only	100%
4482	INFO_LIBRARIAN_DRIVE_7_CLEAN_UNSUCCESSFUL	Drive 7 is still requesting cleaning after being cleaned	Status only	100%
4483	INFO_LIBRARIAN_DRIVE_8_CLEAN_UNSUCCESSFUL	Drive 8 is still requesting cleaning after being cleaned	Status only	100%

<b>FSC</b>	<b>Name</b>	<b>Description</b>	<b>FRU Name</b>	<b>Confidence %</b>
4486	INFO_LIBRARIAN_LEVEL_1_REMOVED	Module at level 1 in stack has been powered down/disconnected	Status only	100%
4487	INFO_LIBRARIAN_LEVEL_2_REMOVED	Module at level 2 in stack has been powered down/disconnected	Status only	100%
4488	INFO_LIBRARIAN_LEVEL_3_REMOVED	Module at level 3 in stack has been powered down/disconnected	Status only	100%
4489	INFO_LIBRARIAN_LEVEL_4_REMOVED	Module at level 4 in stack has been powered down/disconnected	Status only	100%
448A	INFO_LIBRARIAN_LEVEL_5_REMOVED	Module at level 5 in stack has been powered down/disconnected	Status only	100%
448B	INFO_LIBRARIAN_LEVEL_6_REMOVED	Module at level 6 in stack has been powered down/disconnected	Status only	100%
448C	INFO_LIBRARIAN_LEVEL_7_REMOVED	Module at level 7 in stack has been powered down/disconnected	Status only	100%
448D	INFO_LIBRARIAN_LEVEL_8_REMOVED	Module at level 8 in stack has been powered down/disconnected	Status only	100%

<b>FSC</b>	<b>Name</b>	<b>Description</b>	<b>FRU Name</b>	<b>Confidence %</b>
448E	INFO_LIBRARIAN_LEVEL_9_REMOVED	Module at level 9 in stack has been powered down/disconnected	Status only	100%
448F	INFO_LIBRARIAN_LEVEL_10_REMOVED	Module at level 10 in stack has been powered down/disconnected	Status only	100%
4490	INFO_LIBRARIAN_LEVEL_11_REMOVED	Module at level 11 in stack has been powered down/disconnected	Status only	100%
4492	INFO_LIBRARIAN_MODULE_ADDED_TO_STACK	New module has joined stack	Status only	100%
4493	INFO_LIBRARIAN_LEVEL_1_FITTED	Level 1 fitted in stack	Status only	100%
4494	INFO_LIBRARIAN_LEVEL_2_FITTED	Level 2 fitted in stack	Status only	100%
4495	INFO_LIBRARIAN_LEVEL_3_FITTED	Level 3 fitted in stack	Status only	100%
4496	INFO_LIBRARIAN_LEVEL_4_FITTED	Level 4 fitted in stack	Status only	100%
4497	INFO_LIBRARIAN_LEVEL_5_FITTED	Level 5 fitted in stack	Status only	100%
4498	INFO_LIBRARIAN_LEVEL_6_FITTED	Level 6 fitted in stack	Status only	100%
4499	INFO_LIBRARIAN_LEVEL_7_FITTED	Level 7 fitted in stack	Status only	100%
449A	INFO_LIBRARIAN_LEVEL_8_FITTED	Level 8 fitted in stack	Status only	100%

Appendix B Fault Symptom Code (FSC) Dictionary

<b>FSC</b>	<b>Name</b>	<b>Description</b>	<b>FRU Name</b>	<b>Confidence %</b>
449B	INFO_LIBRARIAN_LEVEL_9_FITTED	Level 9 fitted in stack	Status only	100%
449C	INFO_LIBRARIAN_LEVEL_10_FITTED	Level 10 fitted in stack	Status only	100%
449D	INFO_LIBRARIAN_LEVEL_11_FITTED	Level 11 fitted in stack	Status only	100%
449E	INFO_LIBRARIAN_LEVEL_12_FITTED	Level 12 fitted in stack	Status only	100%
449F	INFO_LIBRARIAN_LEVEL_1_NOT_FITTED	Level 1 not fitted in stack	Status only	100%
44A0	INFO_LIBRARIAN_LEVEL_2_NOT_FITTED	Level 2 not fitted in stack	Status only	100%
44A1	INFO_LIBRARIAN_LEVEL_3_NOT_FITTED	Level 3 not fitted in stack	Status only	100%
44A2	INFO_LIBRARIAN_LEVEL_4_NOT_FITTED	Level 4 not fitted in stack	Status only	100%
44A3	INFO_LIBRARIAN_LEVEL_5_NOT_FITTED	Level 5 not fitted in stack	Status only	100%
44A4	INFO_LIBRARIAN_LEVEL_6_NOT_FITTED	Level 6 not fitted in stack	Status only	100%
44A5	INFO_LIBRARIAN_LEVEL_7_NOT_FITTED	Level 7 not fitted in stack	Status only	100%
44A6	INFO_LIBRARIAN_LEVEL_8_NOT_FITTED	Level 8 not fitted in stack	Status only	100%
44A7	INFO_LIBRARIAN_LEVEL_9_NOT_FITTED	Level 9 not fitted in stack	Status only	100%
44A8	INFO_LIBRARIAN_LEVEL_10_NOT_FITTED	Level 10 not fitted in stack	Status only	100%

<b>FSC</b>	<b>Name</b>	<b>Description</b>	<b>FRU Name</b>	<b>Confidence %</b>
44A9	INFO_LIBRARIAN_LEVEL_11_NOT_FITTED	Level 11 not fitted in stack	Status only	100%
44AA	INFO_LIBRARIAN_LEVEL_12_NOT_FITTED	Level 12 not fitted in stack	Status only	100%
4600	FSC_SERVO_POWER_ON_INITIALISATION_COMPLETE	The library's power-on initialization sequence has completed		
4680	FSC_SERVO_DRIVE_1_RELOAD_NECESSARY	Drive 1 has rejected the cartridge, a reload is underway	Drive 1	100%
4681	FSC_SERVO_DRIVE_2_RELOAD_NECESSARY	Drive 2 has rejected the cartridge, a reload is underway	Drive 2	100%
4682	FSC_SERVO_DRIVE_3_RELOAD_NECESSARY	Drive 3 has rejected the cartridge, a reload is underway	Drive 3	100%
4683	FSC_SERVO_DRIVE_4_RELOAD_NECESSARY	Drive 4 has rejected the cartridge, a reload is underway	Drive 4	100%
4684	FSC_SERVO_DRIVE_5_RELOAD_NECESSARY	Drive 5 has rejected the cartridge, a reload is underway	Drive 5	100%
4685	FSC_SERVO_DRIVE_6_RELOAD_NECESSARY	Drive 6 has rejected the cartridge, a reload is underway	Drive 6	100%
4686	FSC_SERVO_DRIVE_7_RELOAD_NECESSARY	Drive 7 has rejected the cartridge, a reload is underway	Drive 7	100%
4687	FSC_SERVO_DRIVE_8_RELOAD_NECESSARY	Drive 8 has rejected the cartridge, a reload is underway	Drive 8	100%

<b>FSC</b>	<b>Name</b>	<b>Description</b>	<b>FRU Name</b>	<b>Confidence %</b>
4900	INFO_STACK_MASTER	This unit has become the stack-master (shuttle controller)	Status only	100%
4901	INFO_STACK_SLAVE	This unit has changed from stack-master to slave module	Status only	100%
4902	INFO_STACK_MASTER_DEAD	The stack-master is no longer polling this unit	Status only	100%
491	INFO_LIBRARIAN_LEVEL_12_REMOVED	Module at level 12 in stack has been powered down/disconnected	Status only	100%

## Appendix C

# DLTtape Cartridge Maintenance

---

This appendix provides guidelines for handling DLT cartridges and visually inspecting cartridges if necessary.

---

## Handling DLTtape Cartridges

- Always keep each tape cartridge in its protective plastic case when it is not in the library.
- When carrying tape cartridges in their cases, always orient the cases so that the grooves in the cases interlock. This prevents the cases from slipping apart and falling.
- Never stack more than five cartridges on top of each other.
- Always observe the proper environmental conditions for the storage of tape cartridges. Refer to the cartridge reference card supplied with each cartridge.
- When placing tape cartridges in archival storage, make sure you stand each tape cartridge vertically.

- Avoid placing tape cartridge near any sources of high intensity magnetic fields, such as computer monitors or electric motors.
- Never apply adhesive labels or POST-IT notes to the top, side, or bottom of your DLTtape cartridge. Only use the user slide-in type label provided with each cartridge and slide it over the label slot on the cartridge.
- Do not carry cartridges loosely in a box or any other container. Allowing cartridges to bang together exposes them to unnecessary physical shock.
- Do not touch or allow direct contact with tape or tape leader. Dust or natural skin oils can contaminate the tape and impact tape performance.
- Do not expose the tape cartridge to moisture or direct sunlight.
- Do not insert a dropped or damaged cartridge into a DLTtape drive without, at the very least, a thorough visual inspection (see [Visual Inspection of DLTtape Cartridges](#)). A dropped cartridge may have dislodged, loosened, or damaged internal components.

---

## Visual Inspection of DLTtape Cartridges

---

### **When To Visually Inspect a DLTtape Cartridge**

It is important to visually inspect a DLTtape cartridge under the following circumstances:

- Whenever you change or load a new tape cartridge
- If the tape cartridge has been dropped or subjected to a physical shock
- If a DLTtape drive becomes inoperable after loading the tape cartridge
- If you receive a shipment of tape cartridges that shows any sign of being damaged



## Visual Inspection Procedure

To visually inspect a DLTape cartridge:

- 1 Check the cartridge for any obvious cracks or other physical damage.
- 2 Gently shake the tape cartridge. Listen for any rattling of loose pieces inside the cartridge.

**Caution:** If you hear anything loose inside the cartridge, do not use the cartridge.

- 3 Locate the reel lock openings (see [figure 57](#)) and verify that you can see the reel locks.

The reel locks are small plastic tabs near the center of the reel lock openings. They can be broken if the cartridge is dropped.

**Caution:** If the reel locks are not visible, do not use the cartridge.

Figure 57 Location of the Reel Locks and the Hub

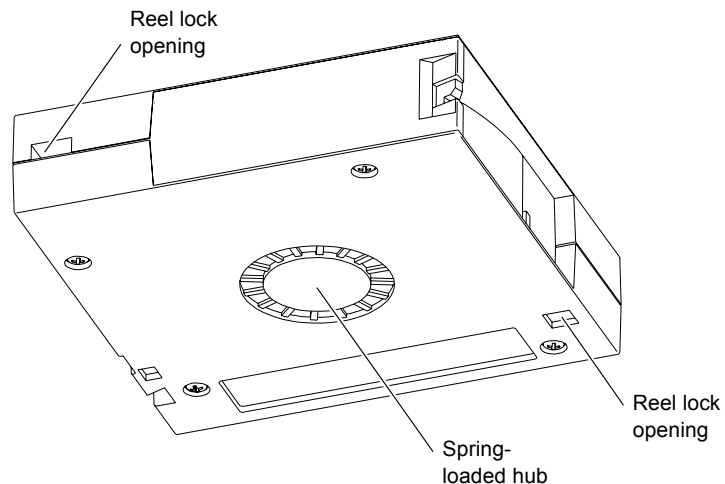

- 4 Verify that the spring-loaded hub (see [figure 57](#)) is centered within the circular opening in the tape cartridge.

- 5 Gently press the hub, then release it. Make sure the hub springs back into place and is still centered within its circular opening.
- 6 Open the tape cartridge door (see [figure 58](#)):
  - a Gently press up on the tab at the right side of the tape cartridge door.
  - b Swing the door open.

Figure 58 Opening the Tape Cartridge Door

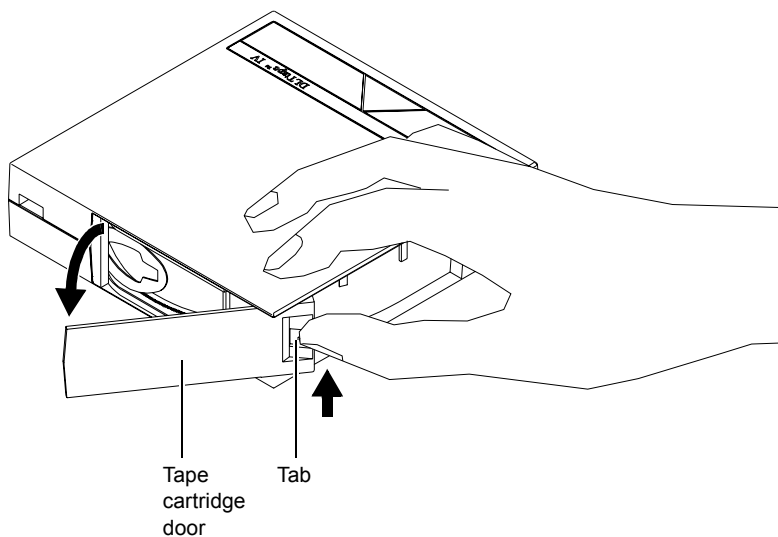

- 7 Verify that:
  - The tape is wound tightly on the reel
  - The tape leader loop is sticking up about an eighth of an inch
  - The tape leader loop is not bent or torn

**Caution:** If any of the above conditions are not met, do not use the cartridge.

- 8 Check for proper operation of the tape cartridge's write-protect switch (see [figure 59](#)).

The switch should snap back and forth, and the orange tab should be visible when the switch is in the write-protected position.

Figure 59 Write  
Protect Switch

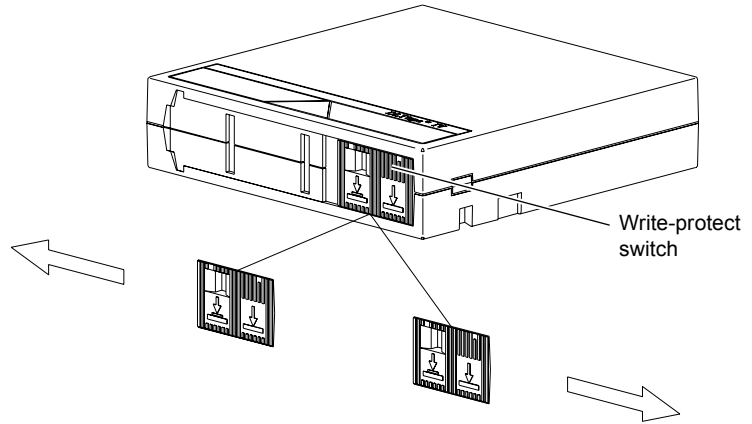

Appendix C DLTtape Cartridge Maintenance  
Visual Inspection of DLTtape Cartridges

## Appendix D

# Regulatory Statements

---

---

## FCC Statement

This equipment has been tested and found to comply with the limits for a Class A digital device, pursuant to Part 15 of the FCC Rules. These limits are designed to provide reasonable protection against harmful interference when the equipment is operated in a commercial environment. This equipment generates, uses, and can radiate radio frequency energy and, if not installed and used in accordance with the instruction manual, may cause harmful interference to radio communications.

Any changes or modifications made to this equipment may void the user's authority to operate this equipment.

Operation of this equipment in a residential area may cause interference in which case the user at his own expense will be required to take whatever measures may be required to correct the interference.

This device complies with Part 15 of the FCC Rules. Operation is subject to the following conditions:

- 1 This device may not cause harmful interference, and
- 2 This device must accept any interference received, including interference that may cause undesired operation.

---

## Taiwan Statement

警告使用者:

這是甲類的資訊產品，在居住的環境中使用時，可能會造成射頻干擾，在這種情況下，使用者會被要求採取某些適當的對策。

---

## Industry Canada (Digital Apparatus)

**Reference:** *Interference-Causing Equipment Standard, ICES-003, Issue 2*

This Class A digital apparatus meets all requirements of the Canadian Interference-Causing Equipment Regulations.

---

**CISPR-22  
Warning!**

This is a Class A product. In a domestic environment this product may cause radio interference in which case the user may be required to take adequate measures.

---

## Notice for USA and CANADA Only

If shipped to USA, use the UL LISTED power cord specified below for 100-120 V operation. If shipped to Canada, use the CSA CERTIFIED power cord specified below for 100-120V operation.

Plug Cap	Parallel blade with ground pin (NEMA 5-15P configuration)
Cord	Type: SJT, three 16 AWG (1.5 mm <sup>2</sup> ) or 18 AWG (1.0 mm <sup>2</sup> ) wires
Length	Maximum 15 feet (4.5m)
Rating	Minimum 10 A, 125 V

---

## Laser Statement

---

**Class 1 Laser  
Product**

**CAUTION:** With all panels and enclosures in place, this product is rated as a Class I laser product. The bar code scanner inside this product, however, is a Class II laser. Avoid exposure to the laser light emitted from the bar code scanner. Do not stare into the beam.

**CAUTION:** Use of controls or adjustments or performance of procedures other than those specified herein may result in hazardous exposure.

---

## Library Battery Statement

---

**Caution**

This product contains a Lithium battery. The nonvolatile RAM, Dallas Semiconductor DS1743-100, contains a Lithium battery. Lithium may be considered a hazardous material. Dispose of this battery in accordance with local, state, and federal laws.

---

## MC300 Battery Statement

---

**Caution**

Danger of explosion if battery is incorrectly replaced.

Replace only with the same or equivalent type recommended by the manufacturer. Dispose of used batteries according to the manufacturer's instructions.



# Declaration of Conformity

Figure 60 Declaration of Conformity, L25



**M4 Data Ltd**  
Mendip Court  
Bath Road  
Wells  
Somerset  
BA5 3DG  
Tel: (+44) (0)1749 683800  
Fax: (+44) (0)1749 673928  
www.m4data.com

## EC DECLARATION OF CONFORMITY

**Date of Issue :** 4 June 2002

**Equipment :** Models M1500, L25 tape libraries manufactured for Quantum SSG. Configured as rack mount unit and supplied with optional StackLink or as a desktop unit. Tape drives fitted can be models DLT4000, DLT7000, DLT8000, SDLT, manufactured by Quantum or Tandberg Data, or LTO models manufactured by Hewlett Packard or Seagate. Optional cards MC300, FC310, or FC420 may be fitted. Optional redundant power supply Etasis EFRP-2302A-607.

**EC Directives :** Low Voltage Directive 73/23/EEC as amended by 93/68/EEC. EMC Directive 89/336/EEC as amended by 92/31/EEC and 93/68/EEC

**Safety Standard :** EN 60950:1992/A2:1994 including annexes ZB and ZC. Safety of information technology equipment, including electrical business equipment.

**EMC Standards :** EN 55022:1998 Class A (SCSI Interface)  
Limits and methods of measurement of radio interference characteristics of information technology equipment.

EN 55024:1998. Information technology equipment - Immunity characteristics - Limits and methods of measurement.

EN61000-3-2:1995 + A1/A2/A14. Limits for harmonic current emissions.

EN61000-3-3:1995. Limitations of voltage fluctuations and flicker in low voltage supply systems for equipment with rated current <16A.

It is hereby certified that models M1500, L25 Data Storage Units, specified above and manufactured in the United Kingdom or Malaysia, conform with the requirements of the specifications noted above and hence with both the Low Voltage Directive for Product Safety and the EMC Directive.

### Authorised Representative:

Signature :

Name : David S Cutler

Title : Regulatory Approvals Manager

Company : M4 Data Ltd., Mendip Court, Bath Road, Wells, Somerset. BA5 3DG

The CE Mark was first applied in 2001

Registered in England 2386452  
Registered Office: Mendip Court, Bath Road, Wells, Somerset BA5 3DG



**M4 Data Ltd**  
Saxony Way  
Blackbushe, Yateley  
Hampshire GU14 6GY  
England  
Tel: (+44) (0)1252 864600  
Fax: (+44) (0)1752 864601  
sales@m4data.co.uk  
www.m4data.com

**M4 Data Inc**  
44518 Enterprise Court  
Melbourne  
Florida 32934  
USA  
Tel: (+1) 321 255 0666  
Fax: (+1) 321 252 0970  
sales@m4data-usa.com  
www.m4data.com

Wyoming office  
Tel: (+1) 307 632 9957  
Fax: (+1) 307 632 9982  
Colorado office  
Tel: (+1) 303 554 0990  
Fax: (+1) 303 554 0990  
sales@m4data-usa.com  
www.m4data.com

**M4 Data GmbH**  
Ludwig Wagner Strasse 41a  
D-69168 Wiesloch  
bei Heidelberg  
Germany  
Tel: (+49) 6222 9228 0  
Fax: (+49) 6222 9228 22  
vertrieb@m4data.de  
www.m4data.de

**M4 Data (India)**  
C 210, Suphrie  
Anandhally  
Bangalore - 560 092  
India  
Tel/Fax: (+91) 80 856 1879  
m4data@india.m4data.com  
www.m4data.com

**M4 Data Ltd**  
Beijing Office  
Room 57245, Xiyuan Hotel  
Beijing 100044, China  
Tel: (+86) 10 6831 3388  
ext: 57246 to 57249  
Fax: (+86) 10 6835 1665  
m4c@public3.data.net.cn  
www.m4data.com

**M4 Data Ltd**  
Mendip Court  
Bath Road, Wells  
Somerset BA5 3DG  
England  
Tel: (+44) (0)1749 683800  
Fax: (+44) (0)1749 673928  
sales@m4data.co.uk  
www.m4data.com

Figure 61 Declaration of Conformity, L100



**M4 Data Ltd**  
Mendip Court  
Bath Road  
Wells  
Somerset  
BA5 3DG  
Tel: (+44) (0)1749 683800  
Fax: (44) (0)1749 673928  
www.m4data.com

**EC DECLARATION OF CONFORMITY**

- Date of Issue :** 4 June 2002
- Equipment :** Models M2500, L100 tape libraries manufactured for Quantum SSG. Configured as rack mount unit and supplied with optional StackLink or as a desktop unit. Tape drives fitted can be models DLT4000, DLT7000, DLT8000, SDLT, manufactured by Quantum or Tandberg Data, or LTO models manufactured by Hewlett Packard or Seagate. Optional cards MC300, FC310, or FC420 may be fitted. Optional redundant power supplies Etasis EFRP-2302A-607.
- EC Directives :** Low Voltage Directive 73/23/EEC as amended by 93/68/EEC. EMC Directive 89/336/EEC as amended by 92/31/EEC and 93/68/EEC
- Safety Standard :** EN 60950:1999 (3<sup>rd</sup> Edition). Safety of information technology equipment, including electrical business equipment.
- EMC Standards :** EN 55022:1998 Class A (SCSI Interface) Limits and methods of measurement of radio interference characteristics of information technology equipment.  
EN 55024:1998. Information technology equipment - Immunity characteristics - Limits and methods of measurement.  
EN61000-3-2:1995 + A1/A2/A14. Limits for harmonic current emissions.  
EN61000-3-3:1995. Limitations of voltage fluctuations and flicker in low voltage supply systems for equipment with rated current <16A.

It is hereby certified that models M2500, L100 Data Storage Units, specified above and manufactured in the United Kingdom conform with the requirements of the specifications noted above and hence with both the Low Voltage Directive for Product Safety and the EMC Directive.

**Authorised Representative :**

Signature :

Name : David S Cutler

Title : Regulatory Approvals Manager

Company : M4 Data Ltd., Mendip Court, Bath Road, Wells, Somerset. BA5 3DG

The CE Mark was first applied in 2002

Registered in England 2396452  
Registered Office: Mendip Court, Bath Road, Wells, Somerset BA5 3DG



<p><b>M4 Data Ltd</b> Saxony Way Blackbushe, Yateley Hampshire GU46 6GY England Tel: (+44) (0)1252 864600 Fax: (+44) (0)1752 864601 sales@m4data.co.uk www.m4data.com</p>	<p><b>M4 Data Inc</b> 4451B Enterprise Court Melbourne Florida 32934 USA Tel: (+1) 321 255 0666 Fax: (+1) 321 252 0970 sales@m4data-usa.com www.m4data.com</p>	<p>Wyoming office Tel: (+1) 307 632 9957 Fax: (+1) 307 632 9962 Colorado office Tel: (+1) 303 954 0990 Fax: (+1) 303 954 0980 sales@m4data-usa.com www.m4data.com</p>	<p><b>M4 Data GmbH</b> Ludwig Wagner Strasse 41a D-69168 Wiesloch bei Heidelberg Germany Tel: (+49) 6222 9228 0 Fax: (+49) 6222 9228 22 vertrieb@m4data.de www.m4data.de</p>	<p><b>M4 Data (India)</b> C-210, Sapphire Anushakti Bangalore 560 092 India Tel: (+91) 80 856 1879 m4dataindia@vsnl.com www.m4data.com</p>	<p><b>M4 Data Ltd</b> Beijing Office Room 57245, Xiyuan Hotel Beijing 100044, China Tel: (+86) 10 6831 3388 ext: 57246 to 57260 Fax: (+86) 10 6835 1665 m4c@m4data.com.cn www.m4data.com</p>	<p><b>M4 Data Ltd</b> Mendip Court Bath Road, Wells Somerset BA5 3DG England Tel: (+44) (0)1749 683800 Fax: (+44) (0)1749 673928 sales@m4data.co.uk www.m4data.com</p>
---	--	---	--	--	--	--

# Glossary

---

---

## B

**back panel** The panel at the back of the library that contains the power switch and connectors for attaching external cabling to the library.

**bar code label** The identification label on cartridges.

**bar code scanner** A laser device that is mounted on the robotic hand and reads the cartridge bar code labels.

---

## C

**calibration** The software measurements and configuration required for successful operation of the library.

---

## F

**FCC Class A** Standard established by the U.S. Federal Communications Commission governing electromagnetic emissions.

**FSE** Field service engineer

---

## G

**GUI** Graphical user interface. The panel on the front of the L25 and L100 libraries that provides the user interface.

---

## H

**host computer** The computer that issues SCSI commands to control the library robotics.

<hr/> <b>M</b>	<b>MTBF</b> Mean Time Between Failures <b>MTTF</b> Mean Time To Repair
<hr/> <b>N</b>	<b>NVRAM</b> Nonvolatile random access memory
<hr/> <b>O</b>	<b>on-line</b> Ready for communications with a host
<hr/> <b>P</b>	<b>pick</b> The act of removing a cartridge from one location in preparation for placing it in another location. <b>place</b> The act of placing a cartridge in a location after it has been picked from another location. <b>PROM</b> Programmable read-only memory
<hr/> <b>R</b>	<b>RAM</b> Random access memory
<hr/> <b>S</b>	<b>SCSI</b> Small Computer System Interface. A communications standard for attaching peripheral equipment to small computers.
<hr/> <b>T</b>	<b>tape drive</b> The mechanism that reads data from, and writes data to, a tape.
<hr/> <b>U</b>	<b>UL</b> Underwriters Laboratories

# Index

---

---

## A

- Auto-Clean option, turning on or off 72
- Auto-Import option, turning on or off 74–75

---

## B

- Back panel 11
- Bar code scanner, enabling or disabling 66
- Barcode Scanner test, running 87–88
- Baud rate, setting 67

---

## C

- Cartridge magazines, removing 38–45
- Cartridges
  - handling 159–160
  - importing and exporting 31–37
  - inspecting for damage 160–163
  - moving 26–29
- Cleaning a tape drive 79–80
- Confidence test 98–99
- Configuration screen, accessing 53
- Configuration, library, changing 53–75
- Contrast, GUI, adjusting 83–84

---

## D

- Date, setting 68–69
- Demonstration programs, running 97–104
- Diagnostic tests, running 85–95
  - Barcode Scanner test 87–88
  - Display test 95
  - Move Location test 92–95
  - Move Medium test 89–92
- Diagnostics Menu screen
  - accessing 85
- Display test 95
- Drive
  - cleaning 79–80
  - information, viewing 22
  - power, turning on or off
    - using Quick View Menu screen 24–26
    - using the Maintenance screen 81–83
  - serialization, turning on or off 62
  - statistics, viewing 48

---

## E

- Emulation, setting 59
- Exporting tape cartridges 31–37

---

## F

- Fault symptom codes
  - see FSCs
- Front panel 5
- FSCs 111–158

---

## G

- GUI
  - contrast, adjusting 83–84
  - overview 14–19

---

## I

- Ignore Host Lock option, turning on or off 73
- Illumination, turning on or off 64
- Import/Export option, setting 69–71
- Importing tape cartridges 31–37
- Information, viewing
  - drive 22
  - inventory 23
  - library 20–21
- Inventory information, viewing 23

---

## L

- Library
  - configuration, changing 53–75
  - features 5–12
    - back panel 11
    - front panel 5
  - information, viewing 20–21
  - statistics, viewing 47

---

**M**

Magazines, removing 38–45  
Maintenance screen, accessing 77  
Manual access port (MAP) 70  
Move Location test, running 92–95  
Move Medium test, running 89–92

---

**O**

Off-line time, setting 65

---

**Q**

Quick View Menu screen 19–26

---

**S**

SCSI history, viewing 49  
SCSI IDs, setting  
    library 55  
    tape drive 56–57  
Serialization, turning on or off 62  
Short Labels option, turning on  
    or off 63  
Statistics, library, viewing 45–50  
Sync negotiation, turning on or off 60

---

**T**

Tape cartridges  
    handling 159–160  
    importing and exporting 31–37  
    inspecting for damage 160–163  
    moving 26–29  
Tape drive, cleaning 79–80  
Terminator power  
    turning on or off 58  
Time, setting 67–68

---

**W**

Wide negotiation, turning on or off 61

