



StorEdge™ L7 User's Guide

Document Number 6-00446-01 Rev A

Copyright

Copyright Notice

© 2002 Sun Microsystems, Inc. The information contained in this document is subject to change without notice.

This document contains proprietary information which is protected by copyright. All rights are reserved. No part of this document may be photocopied, reproduced, or translated to another language without prior written consent of Sun.

Sun shall not be liable for errors contained herein or for incidental or consequential damages (including lost profits) in connection with the furnishing, performance or use of this material whether based on warranty, contract, or other legal theory.

Sun, Sun Microsystems, and StorEdge are trademarks of Sun Microsystems, Inc. All trademarks are the property of their respective owners.



Introduction

- **Description**
- **Features**
- **Drive**
- **SCSI Interface**
- **Switches and Indicators**
 - **Back Panel**
 - **Front Panel**
- **Media**
- **Other Requirements**
 - **SCSI Host Adapter**
 - **Application Software**

Safety

- **Warnings**
- **Precautions**

Getting Started

- **Unpacking and Inspecting**
 - **Checking the Accessories**
- **Installing the SCSI Cable and Terminator**
 - **Connecting more than one StorEdge L7**
- **Preparing the Host System**

Operation and Maintenance

- **Normal Operations**
 - **Powering on the System**
 - **Performing Power-up Checks**
 - **Setting SCSI IDs**
 - **Installing Data Cartridges**
 - **Drive Status Messages**
- **Autoloader Modes**
 - **Mode 1A—LOAD DRV**
 - **Mode 1B—EJECT DRV**
 - **Mode 2—LOAD SLOT**
 - **Mode 3—EJECT SLOT**
 - **Mode 4—EJECT PCKR**
 - **Mode 5—DENSITY**
 - **Mode 6—SET SCSI ID**
- **Normal Maintenance**
 - **Cleaning the Drive Head**
 - **Cleaning Tape**
 - **Cleaning the Enclosure**

Troubleshooting and Diagnostics

- **Installation Problems**
- **Loader and Drive Operational Problems**
- **Using the Diagnostic Menu**
 - **Display Firmware**
 - **Sign On**
 - **Change Mode**

- Cycle Test
- Clean Drive
- Autoclean
- Load Firmware
- Display Counts
- Upgrade Drive Firmware
- Error Messages
- Environmental Considerations
- Moving or Shipping the Autoloader
 - De-Racking
 - Removing a Barcode Reader
- Contacting Support
 - Support Contact Information

Specifications

- Drive
- Loader
- Reliability
- Physical
- Power Consumption
- Environment

Regulatory Notices

- Federal Communication Commission Notice
- IC Notice (Canada Only)
- EN 55022 Compliance (Czech Republic Only)
- CE Notice
- VCCI Notices (Japan Only)
- Declaration of Conformity

Introduction

This Chapter ...

- provides a physical description of the switches, indicators, and connectors on the front and back panels of the StorEdge L7
- describes the drive and media used in the StorEdge L7
- describes other requirements (additional hardware and/or software) needed to use the StorEdge L7
- provides a brief overview of the StorEdge L7 features. For detailed specifications, see [Specifications](#)



Welcome to your Sun StorEdge™ L7 autoloader (hereafter referred to as "autoloader"). Your autoloader is a fully automated, high-performance, high-capacity, mass storage system. The autoloader is designed to provide you with unattended, near-line and off-line data storage, archiving, backup, hierarchical storage management (HSM), and retrieval for low- and mid-range servers and networks.

Description

The autoloader is a SCSI compatible and economical data storage device. It incorporates a streaming tape cartridge data storage device, which features high capacity, high throughput, and data compression. Equipped with a Quantum® DLT™ drive, your autoloader operates as two SCSI devices on a single SCSI bus. It can contain up to seven data cartridges providing a maximum formatted capacity of 560 GB and a sustained data transfer rate as high as 720 MB per minute. The tape media is rated at up to 1,000,000 passes and has a shelf life of 30 years, providing superior media durability and data reliability.

The autoloader is compatible with all operating systems and environments supporting the SCSI interface, but requires either direct support of the operating system or a suitable application program to take advantage of its features. Hosting environments that do not directly support SCSI interfaces, like most personal computers, require the addition of a SCSI Host Adapter card.

Your autoloader is capable of operating in either Random-Access or Sequential-Access modes. In Random-Access mode, the application software controls cartridge management. In Sequential-Mode, the autoloader

operating firmware predefines cartridge management. Refer to the "Change Mode" section in [Troubleshooting and Diagnostics](#), for a detailed description of Sequential-Mode operation.

Features

Your autoloader has the following features:

- **Multi-function Operator Panel.** The Operator Panel, located to the right, under the front door, employs a 1-line by 10-character liquid crystal display (LCD), a four-key keypad, and three LEDs to permit you to monitor and control the operations of your library. Specific areas of the LCD provide you with information such as: status of the tape storage slots (empty, or data cartridge present); which cartridge is loaded into the drive; status of the cartridge in the drive (write-protected or data compression enabled); and inform you when the drive requires cleaning.
- **Media Transporter.** The media transporter is the media cartridge handling mechanism and normally responds to commands from the application software to move the cartridges between the storage slots and the drive. Employing a bi-directional, pass-through gripper, the media transporter picks and places cartridges to/from the front and rear mounted storage slots.
- **System Integrity.** The cartridge storage slots, drive, and robotics are protected by a physically lockable door.
- **Cleaning Cartridge.** Although the cleaning cartridge can occupy a cartridge storage slot in the autoloader (facilitating automated cleaning cycles), manual insertion of a cleaning cartridge is permitted by opening the front door and installing the cleaning cartridge into any unoccupied storage slot. The Operator Panel is then used to load/unload the cleaning cartridge to/from the drive.
- **Manual Cartridge Use.** Individual cartridges can easily be transported to the drive by manually opening the front door and installing the cartridge into any unoccupied storage slot. The Operator Panel is then used to load cartridges to the drive.
- **Cartridge Pre-Check.** Whenever you power up your autoloader, it will scan the cartridge storage slots and the drive and build a log of valid cartridge locations.
- **Reverse Cartridge Protection.** The five front cartridge storage slots are designed to prevent the cartridges from being inserted incorrectly.
- **Built-in Diagnostics.** Your autoloader includes diagnostic firmware that tells you when drive head cleaning is required, reports diagnostic results, and drive operating status.
- **Barcode Ready.** The available barcode reader option delivers instant media verification and inventory.

Drive

Your autoloader is equipped with a fourth-generation DLT (Digital Linear Tape) drive. The DLT 8000 drive can read and write 10.0, 15.0, 20.0, and 35.0 GB tape formats for 100% interchange compatibility with the DLT 2000, DLT 2000xt, DLT 4000, and DLT 7000 drives. DLT 8000 default tape density is 40 GB (80 GB compressed) when using the DLTape IV data cartridge, see [Table 1](#). Tape density is selectable by the application software or via the Operator Panel.

Table 1. Maximum Capacity and Sustained Transfer Rates

--	--	--	--	--	--

Model	Drive Model	Cartridge Max Capacity (density - compressed mode)	Max Capacity (compressed mode)	Sustained Transfer Rate (compressed mode)
StorEdge L7	DLT8000	20 GB (DLTtape III) 30 GB (DLTtape IIIXT) 80 GB (DLTtape IV)	140 GB 210 GB 560 GB	12.0 MB/sec (720 MB/min)

SCSI Interface

The StorEdge L7 is equipped with a Quantum-manufactured drive and a corresponding robotics interface. The drive and robotics have a High Voltage Differential (HVD) SCSI interface.

CAUTION: HVD devices are NOT compatible with SE and LVD/SE devices. Equipment damage may occur if you connect your StorEdge L7 to an incompatible SCSI bus.

Switches and Indicators

The following figures show the switches and indicators located on the front and back panels of the autoloader.

Back Panel

The back panel of the autoloader is shown in [Figure 1](#).

Figure 1. StorEdge L7 Back Panel

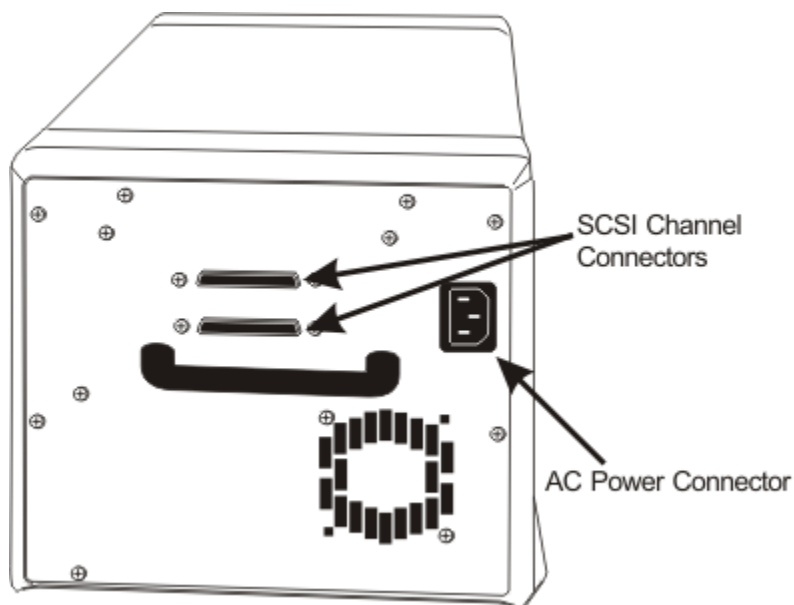

AC Power Connector

Receptacle for AC power cord.

SCSI Channel Connectors

Connections for the interface cable that connect the unit with the host system and/o other devices on the SCSI channel (including additional StorEdge L7 units). The interface cable can be attached to either connector.

Front Panel

The front panel of the autoloader is shown in [Figure 2](#).

Figure 2. StorEdge L7 Front Panel

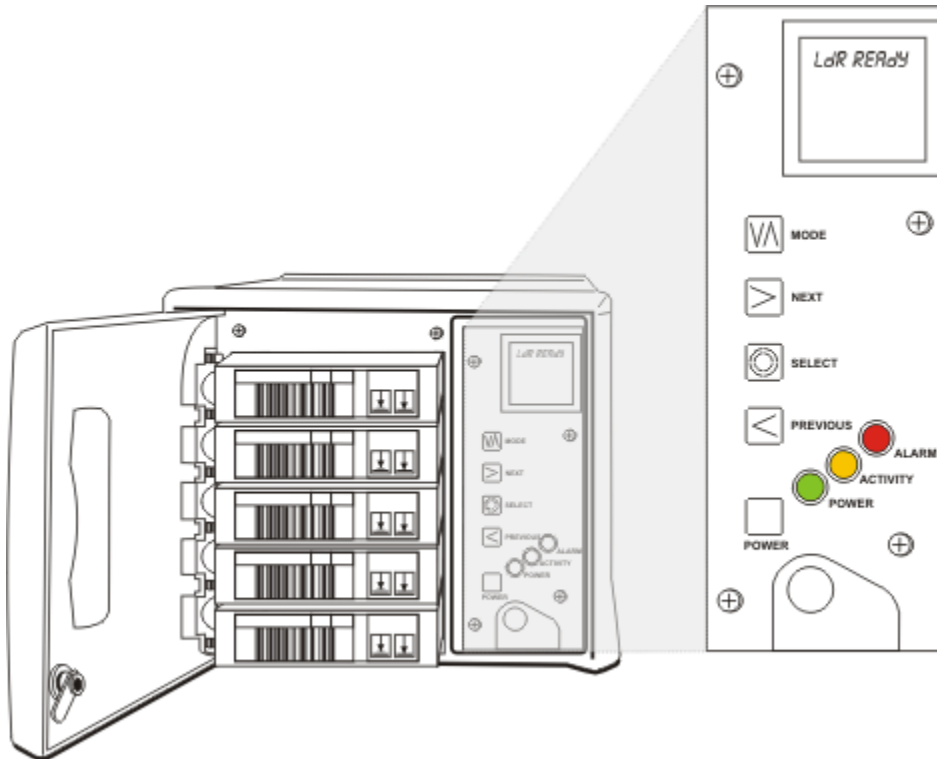

Power LED (green)	Illuminates when power is on.
Activity LED (blinking amber)	Indicates robotic and drive activity. A slow blinking interval indicates autoloader robotic activity and a fast interval indicates drive activity.
Alarm LED (red)	Illuminates whenever an error has occurred.
LCD	1-line by 10-character liquid crystal display. Displays information about drive status, operational messages, and error messages.

[Figure 3](#) shows the layout of the LCD. The normal on-line message (LdR REAdY) is displayed on the top line. On-line, off-line, and error messages also appear on this line.

Figure 3. Operator Panel LCD



DC indicates that data compression is selected on the drive.

WP indicates that a write-protected data cartridge is loaded into the drive.

CT indicates that the drive head needs to be cleaned.

The large numeric field in the center of the display normally indicates which cartridge is loaded into the drive. Whenever an error occurs an **E** will appear in this field and the error message will appear on the top line of the display (see [Troubleshooting and Diagnostics](#) for descriptions of the possible error messages).

The activity bars on the right side of the display, in conjunction with the Activity LED, indicate robotic and drive activity. A blinking bottom bar is displayed when no activity is taking place. A slow interval between the bars appearing/disappearing indicates robotic activity, and a fast interval indicates drive activity.

The seven numeric fields at the bottom of the display indicate the current cartridge inventory. Each will appear only if a cartridge is present in the appropriate storage slot.

[Figure 4](#) provides details on the Operator Panel.

Figure 4. Operator Panel Details

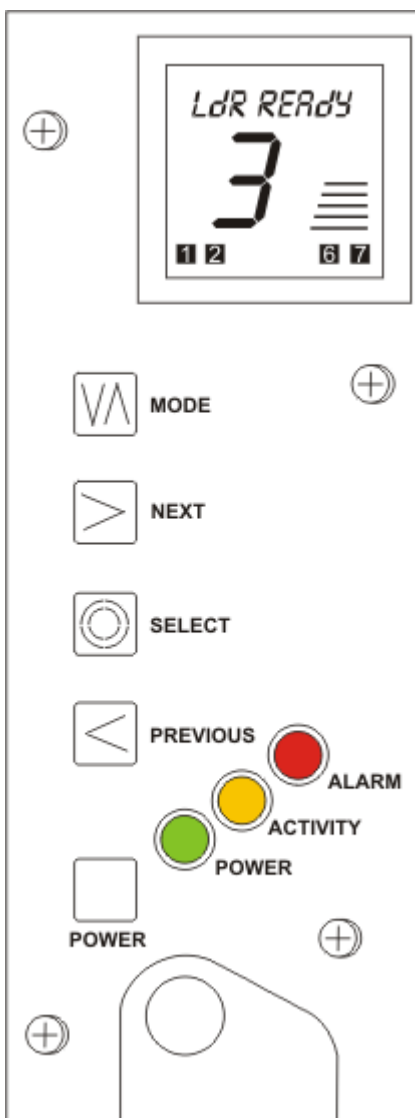

The keypad is described in [Table 2](#).

Table 2. Operator Panel Keypad

Keypad	
MODE	Press this button to enter or exit off-line mode menus.
NEXT	Selects next item or value in the currently displayed menu.
SELECT	Causes the autoloader to execute the current menu (displayed on the top line of the LCD).
PREVIOUS	Selects previous item or value in the currently displayed menu.
POWER	Press and release this button to turn on your autoloader. Press and hold this button for two seconds to turn off your autoloader. POWER dOWN will appear on the LCD and the activity bars (see Indicators above) and Activity LED will indicate robotic activity as the picker moves to its power down position.

Media

The data cartridges used in the DLT drive are housed in 4-inch plastic cases and employ ½-inch metal particle tape. A cartridge is shown in [Figure 5](#).

Figure 5. DLT Cartridge

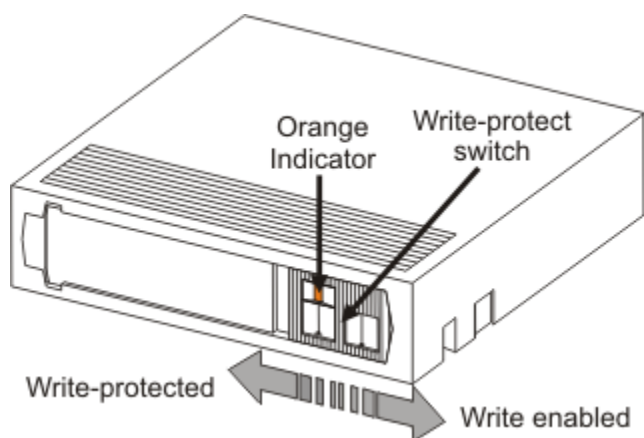

The write-protect switch is used to prevent recording over existing data. To prevent recording or deleting, place the write-protect switch to the open position. The drive senses the position of the switch and will not allow writing in this position. When installing cartridges in the autoloader, place the switch in the closed position (unless you do not wish to record on a specific cartridge).

If the switch is moved all the way to the left, the cartridge is write-protected and the drive cannot write to, or erase data from, the cartridge. The small orange rectangle will be visible whenever the cartridge is write-protected. Additionally, an arrow (beneath the orange rectangle and above the two lines on the switch) lets you know that data cannot be written to the cartridge. If the switch is moved all the way to the right, the cartridge is write-enabled and the drive can write data to, or erase data from, the cartridge. The orange rectangle will not be visible whenever the cartridge is write-enabled. On the right side of the write-protect switch an arrow over one line indicates that if you slide the switch to the right, data can be written to the cartridge.



NOTES:

- Store data cartridges in a dry, cool environment.
 - Never reset or power down your computer or autoloader while a function is in process or a tape is moving.
-

Other Requirements

Below are other requirements for the proper operation of your autoloader.

SCSI Host Adapter

Your autoloader must be connected to either an integrated HVD SCSI host or a separate HVD SCSI interface (host adapter) card installed in the computer—either directly to the I/O connector on the card or as part of an existing SCSI chain. The host adapter you choose will depend on your system requirements and your needs. If you are not sure about your host adapter requirements, please call Sun's Technical Support and ask for assistance. The SCSI interface must be installed before you connect the autoloader.

Application Software

A variety of backup and data storage software is available for use with your autoloader. The software you use will depend upon your storage needs and the system you are using. Please check with Sun Sales or Support if you have a question on the compatibility of a particular software package.

Now you are ready to connect the autoloader to your host system. Follow the instructions provided in [Installation](#).

Safety

This section provides information on the the safety notices for the StorEdge L7.

Warnings



This symbol should alert the user to the presence of "dangerous voltage" inside the product that might cause harm or electric shock.



CAUTION : TO REDUCE THE RISK OF ELECTRIC SHOCK, DO NOT REMOVE COVER (OR BACK). NO USER-SERVICE ABLE PARTS INSIDE. REFER SERVICING TO QUALIFIED SERVICE PERSONNEL.



CAUTION: All safety and operating instructions should be read before this product is operated and should be retained for future reference. This unit has been engineered and manufactured to assure your personal safety. Improper use can result in potential electrical shock or fire hazards. In order not to defeat the safeguards, observe the following basic rules for its installation, use and servicing.

To maintain the safeguards, observe the following basic rules for installation, use, and servicing of the autoloader:

- **Heed Warnings** - All warnings on the product and in the operating instructions should be adhered to.
 - **Follow Instructions** - All operating and use instructions should be followed.
 - **Ventilation** - The product should be situated so that its location or position does not interfere with proper ventilation.
 - **Heat** - The product should be situated away from heat sources such as radiators, heat registers, furnaces, or other heat producing appliances.
 - **Power Sources** - The product should be connected to a power source only of the type directed in the operating instructions or as marked on the product.
 - **Power Cord Protection** - The AC line cord should be routed so that it is not likely to be walked on or pinched by items placed upon or against it, paying particular attention to the cord at the wall receptacle, and the point where the cord exits from the product.
 - **Object and Liquid Entry** - Care should be taken to ensure that objects do not fall and liquids are not spilled into the product's enclosure through openings.
 - **Servicing** - The user should not attempt to service the product beyond that described in the operating instructions. All other servicing should be referred to qualified service personnel.
-

Precautions

- Do not use oil, solvents, gasoline, paint thinners, or insecticides on the unit.
- Do not expose the unit to moisture, to temperatures higher than 60 °C (140 °F), or to extreme low temperatures.
- Keep the unit away from direct sunlight, strong magnetic fields, excessive dust, humidity, and electronic/electrical equipment, which generate electrical noise.
- Hold the AC power plug by the head when removing it from the AC source outlet; pulling the cord can damage the internal wires.
- Use the unit on a firm level surface free from vibration, and do not place anything on top of unit.

Getting Started

This Chapter ...

- explains the steps necessary to set up your autoloader
-

Unpacking and Inspecting

Unpack all items from the carton. Save the packing materials in case you need to move or ship the system in the future.



CAUTION: If the operating environment differs from the storage environment by 15° C (30° F) or more, let the unit acclimate to the surrounding environment for at least 12 hours.

Checking the Accessories

Check to make certain that the following items are included with your autoloader:

- Contents List (printed)
- DLT Media Cartridge
- DLT Cleaning Cartridge
- User's Guide (Localized Documentation CD)
- Quick Start Guide (printed)
- Errata sheet (printed)
- One active 68-pin SCSI bus terminator
- US Power Cord
- Two keys for the front door (located on the back panel of the autoloader)

None of the items should show signs of damage.

Installing the SCSI Cable and Terminator

If your host system does not have native SCSI capability and the host adapter you are using is not installed, please install it. Refer to the manual that came with your host adapter for specific directions. When the host adapter card is installed, return to this point in the manual.

Check to ensure that the interface cable you are planning to use has the appropriate connectors on each end. The autoloader uses a 68-pin HVD SCSI connector on the back panel.



NOTES:

- If your host system's SCSI connector is different from the one on the autoloader, you will need to obtain an adapter or a different cable. Consult your dealer or Sun if you need help.
- The interface cable must be shielded—Sun can supply you with the correct type.

Follow the procedure below to connect the SCSI cable and terminator.

1. Connect the SCSI cable to either of the SCSI connectors on the back panel of the autoloader.
 **NOTE:** SCSI bus TERM POWER is supplied by the robotics interface, not by the drive.
2. Connect the free end of the SCSI cable to the connector on the host system's SCSI adapter.
3. If you wish to connect one or more additional devices to the bus after the autoloader, connect an appropriate cable between the remaining SCSI connector on the rear panel of the autoloader and the next device.
4. Terminate the last device in the chain.

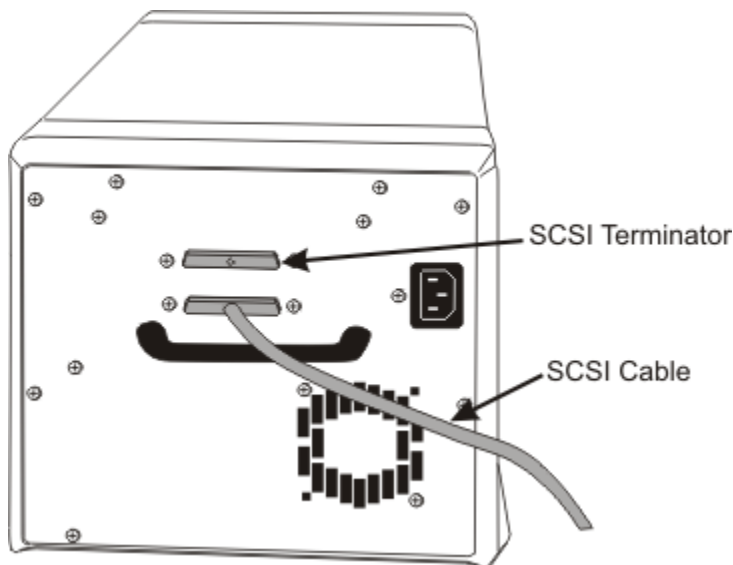

5. Make sure that the SCSI cable between the host adapter and the autoloader is secure and the connections are fastened correctly.

Connecting More than one StorEdge L7

If you are connecting more than one autoloader on the same SCSI channel, connect each unit to the previous unit with an additional shielded interface cable. It does not matter which SCSI connector on each autoloader you connect the interface cable to. Make sure that you configure each autoloader unit with a unique drive SCSI ID and loader ID. Your autoloaders will not function properly if they have the same SCSI IDs. Also, ensure that you terminate the last device in the chain.

Preparing the Host System

At this point you need to refer to your software installation guide for instructions on installing the backup/controlling software for the autoloader onto the host system.

Operation and Maintenance

This Chapter ...

- describes normal operating features of your autoloader
 - provides details on the media and drive head cleaning cartridge
 - explains normal maintenance procedures
-

Normal Operations

Once your autoloader and your choice of application software are installed and configured, you can automatically perform backup and restore operations through the application software. You do not need to intervene unless you need to replace cartridges.

Always follow these general operating guidelines:

- Do not open the front door of the autoloader unless you must perform manual mode commands or change media.
- Use only the recommended types of media cartridges described earlier in this manual.
- Clean the drive whenever the **CT** field appears on the LCD (signifying a cleaning request), or as soon possible.

 **NOTE:** Never insert or remove cartridges from the storage slots unless LdR REAdY is displayed on the LCD.

Powering on the System

The two keys for the front door are taped to the back panel of your autoloader.

1. Remove the keys from the back panel and unlock and open the front door.
2. Remove the foam shipping block from the cartridge area.
3. Plug the power cord into the AC receptacle on the back panel of your autoloader.
4. Plug the power cord from the autoloader into a grounded electrical outlet.



CAUTION: Use caution when plugging the power cord into an electrical outlet. Hazardous volt are present in the sockets of the outlet.

5. Plug the power cord from your host system into a grounded electrical outlet.
6. Turn on power to the autoloader by pressing the **POWER** button on the Operator Panel.



NOTE: When powering off your autoloader, you must press and hold the **POWER** button for two seconds.

While the autoloader initializes, the LCD will appear as shown below. The Activity LED will blink slowly, and the activity bars will appear on the LCD.

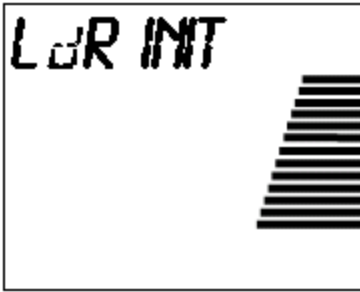

At the completion of autoloader initialization, the drive will initialize and the LCD will appear as shown below. The Activity LED will blink fast, and the activity bars will appear on the LCD.

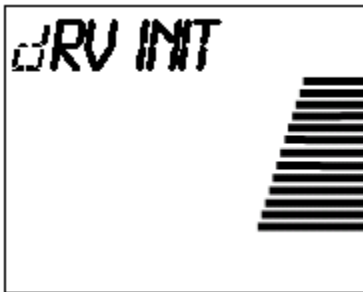

At the conclusion of drive initialization, the LCD will appear as shown below:



Performing Power Up Checks

When you apply power to your autoloader it will perform the following actions:

- Verify drive configuration and status
- Build a valid cartridge inventory log
- Calibrate the media picker

When the autoloader has completed the power up checks, the LCD will display LdR REAdY.

Setting SCSI IDs



NOTES:

- The default settings for the SCSI IDs are: LdR Id: 1, and dRV Id: 3.

- SCSI ID changes are not effective until power has been cycled.

Your autoloader consists of two SCSI devices: the drive and the robotics. Depending upon your requirements, you may need to change the SCSI ID default settings for your installation. To change the SCSI ID of the robotics and/or the drive, perform the following steps:

1. Repeatedly press the **MODE** button on the Operator's Panel until SET SCSI (Mode 6) appears on the first line of the LCD.
2. Press the **SELECT** button. LdR SCSI will now appear on the LCD.
3. Press the **SELECT** button to select the robotics. LdR Id X (where X is the current SCSI ID of the robotics) will now appear on the LCD.
4. Press the **NEXT** button to select a higher ID, or the **PREVIOUS** button to select a lower ID.
5. Press the **SELECT** button to accept the new ID for the robotics. dRV SCSI will now appear on the LCD.
6. Press the **SELECT** button. dRV Id X (where X is the current SCSI ID) will now appear on the LCD.
7. Press the **NEXT** button to select a higher ID, or the **PREVIOUS** button to select a lower ID.
8. Press the **SELECT** button to accept the new ID for the drive. CYCLE PWR (blinking) will now appear on the LCD for approximately 10 seconds.
9. Press and hold the **POWER** button for two seconds to power down the autoloader.
10. Wait a few seconds, then press the **POWER** button again to power up the autoloader. The new SCSI IDs are now in effect.

 **NOTE:** You may need to power cycle your server and reconfigure your application software for them to see these new IDs as well.

Installing Data Cartridges

If necessary, unlock and open the front door to access the cartridge storage slots. Make sure that the write-protect switch is set appropriately on each cartridge. Slide the switch to the appropriate position by pushing it with your finger, see [Figure 1](#).

Figure 1. DLT Cartridge Write-Protect Switch

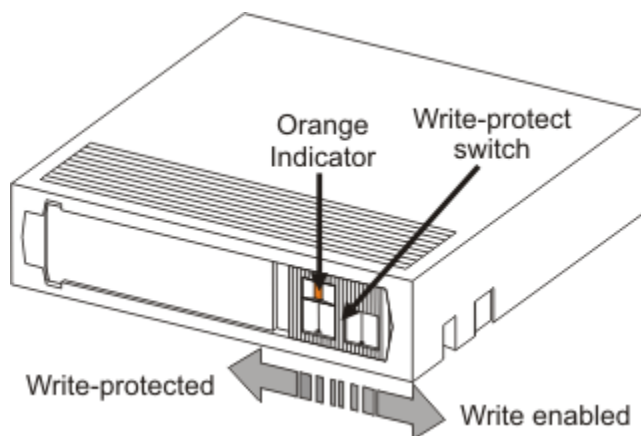

Storage slots 6 and 7 are loaded from slots 1 and 2 respectively, using the Operator's Panel.

 **NOTE:** Never insert or remove cartridges from the storage slots unless LdR REAdY is displayed on the LCD.

To install data cartridges, perform the following steps:

1. Place data cartridges into slots 1 and 2.
2. Verify that the LCD shows that slots 1 and 2 have tapes present.
3. Press the **MODE** button on the Operator's Panel until LOAd SLOT (Mode 2) appears on the first line of the LCD.

 **NOTE:** The LOAd SLOT command always moves the tape from slot 1 to slot 6, and slot 2 to slot 7.

4. Press the **SELECT** button to select the LOAd SLOT command. SRC SLOT 1 will now appear on the LCD.
5. Press the **SELECT** button to execute the LOAd SLOT command.

The autoloader will now move the tape (data cartridge or cleaning tape) from slot 1 to slot 6. While executing, the LdR MOVE, LdR PICK, and LdR PLACE messages will appear on the LCD. When the autoloader has completed the command, LdR REAdY will again appear on the LCD.

6. Verify that the LCD now shows that slots 2 and 6 have tapes present.
7. Press the **MODE** button on the Operator's Panel until LOAd SLOT (Mode 2) appears on the first line of the LCD.
8. Press the **SELECT** button to select the LOAd SLOT command. SRC SLOT 2 will now appear on the LCD.
9. Press the **SELECT** button to execute the LOAd SLOT command.

The autoloader will now move the tape from slot 2 to slot 7. While the command is executing, the activity bars will indicate loader activity, LdR MOVE, LdR PICK, and LdR PLACE messages will appear on the LCD, and the Activity LED on the Operator's Panel will blink slowly. When the autoloader has completed the command, LdR REAdY will appear on the LCD.

10. Verify that the LCD now shows that slots 6 and 7 now have tapes present.
11. Install five additional cartridges into storage slots 1 through 5.
12. Verify that the LCD now shows that slots 1 through 7 have tapes present.
13. Close the autoloader door, turn the key a quarter-turn clockwise, and remove it from the lock.
14. Turn on the host system power and launch the software application.

The application will now control the autoloader. Use the Mode commands, described on the following sections, to manually perform autoloader functions.

Drive Status Messages

During on-line operation, your autoloader will place drive status messages on the top line of the LCD. The following table lists the messages that will appear on the LCD:

Drive Status Message	Description
CALIBRATE	Drive is calibrating head to tracks on tape
EJECTING	Drive is unloading tape

CLEANING	Drive is cleaning head with cleaning cartridge
ERASING	Drive is erasing tape
READING	Drive is reading tape
WRITING	Drive is writing to tape
SEEKING	Drive is seeking a position on tape
REWINDING	Drive is rewinding tape

Autoloader Modes

The following diagram is a quick reference guide to the modes described on the next sections.

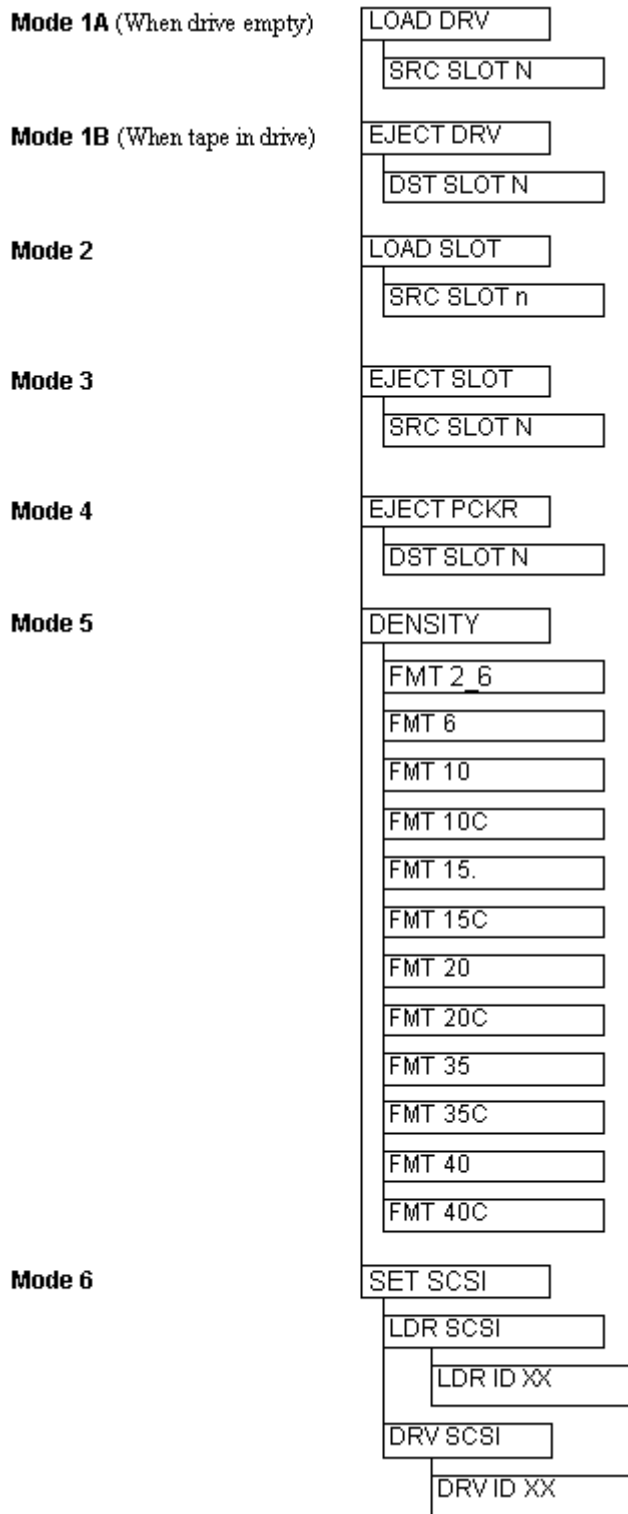

To access any of the modes, press the **MODE** button repeatedly until the LCD displays the desired mode on the top line.

 **NOTES:**

- It is only possible to scroll forward through the mode choices. If you pass the mode desired mode, continue to press the **MODE** button until the mode you desire is again displayed on the LCD.

- While accessing Modes 1-6, the autoloader is not available to your software application.

To exit any of the modes and return to LdR REAdY, press the **MODE** button.

Mode 1A - LOAD DRV

Mode 1A causes your autoloader to load a tape into the drive.

 **NOTE:** If a tape is already loaded in the drive, Mode 1A is not selectable on the LCD, however, Mode 1B is selectable.

To access Mode 1A, press the **MODE** button until the LCD appears as shown:

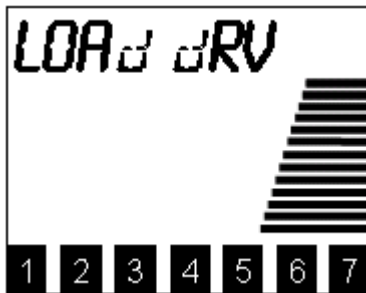

Press the **SELECT** button to choose this mode. The LCD appears as shown:

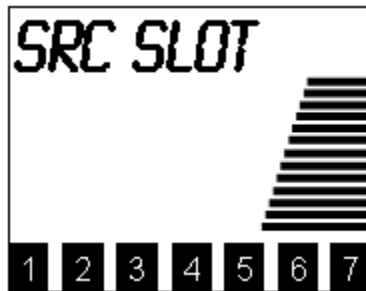

Use the **NEXT** or **PREVIOUS** button to scroll through the slot choices. Press **SELECT** when the slot you wish to load is displayed.



Your autoloader will load the desired tape into the drive. After completing the task, the autoloader will return to LdR REAdY, and the slot number of the tape in the drive will be displayed in the center of the LCD.

Mode 1B - EJECT DRV

Mode 1B causes the autoloader to eject the tape from the drive and place it into the storage slot that it was loaded from.

 NOTE: If the drive is empty, Mode 1B is not selectable on the LCD.

To access Mode 1B, press the **MODE** button until the LCD appears as shown:



Press the **SELECT** button to select Mode 1B. The LCD will appear as shown while the drive ejects the tape:

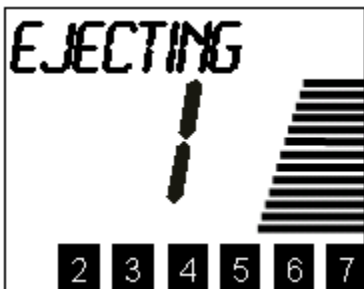

When your autoloader has completed the command, it will return to LdR REAdY.



Mode 2 - LOAD SLOT

Mode 2 causes the autoloader to load slot 6 from slot 1, or slot 7 from slot 2.

 NOTE: If slots 6 and 7 already have cartridges, Mode 2 is not selectable on the LCD.

Place a cartridge in slot 1 if loading slot 6, slot 2 if loading slot 7, or both if loading slots 6 and 7.

To access Mode 2, press the **MODE** button until the LCD appears as shown:

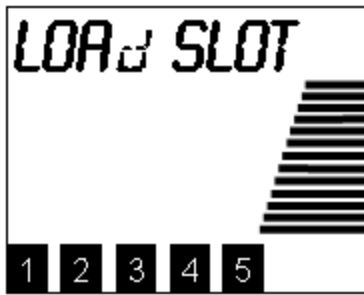

Press the **SELECT** button to select Mode 2. The LCD will appear as shown (N is either slot 6 or 7):

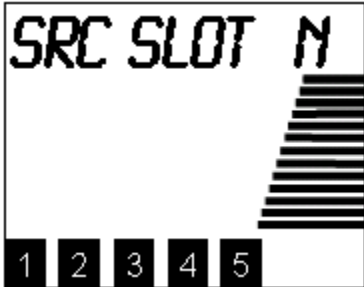

Press the **SELECT** button to move the cartridge from slot 1 to slot 6, or from slot 2 to slot 7. After moving the cartridge autoloader will return to LdR REAdY.

Mode 3 - EJECT SLOT

Mode 3 causes the autoloader to move a tape from slot 6 to slot 1, or from slot 7 to slot 2.

 **NOTE:** If the source slot is empty, or the destination slot is full, selecting EJECT SLOT will cause a blinking RESELECT to appear on the LCD. The blinking RESELECT indicates that you attempted to select an invalid mode.

To access Mode 3, press the **MODE** button until the LCD appears as shown:

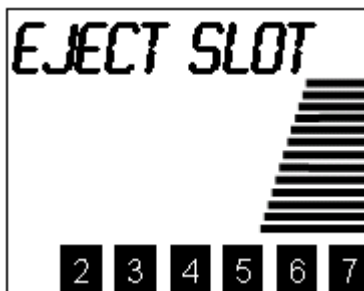

Press the **SELECT** button to select Mode 3. The LCD will appear as shown (N is either 6 or 7):

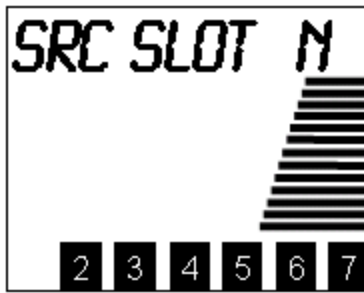

Press the **NEXT** or **PREVIOUS** button to scroll to choose slot 6 or 7 to eject.

Press select when the slot you wish to eject is displayed. The autoloader will move the tape from the source slot to the appropriate destination slot.

 **NOTE:** EJECT SLOT always moves the tape in slot 6 to slot 1, and slot 7 to slot 2.

When your autoloader has completed the command, it will return to LdR REAdY.

Mode 4 - EJECT PCKR

Mode 4 causes the autoloader to eject a tape left in the media picker at power down to any empty destination slot.

 **NOTES:**

- A tape will normally not be left in the picker at power down.
- Executing EJECT PCKR Mode when the media picker does not have a tape will result in PCKR EMPTY and a large **E** (indicating an error condition) appearing on the LCD for approximately 25 seconds. If this occurs, you may press the **MODE** button to return the autoloader the LdR REAdY before the 25 seconds elapses.

To access Mode 4, press the **MODE** button until the LCD appears as shown:



Press the **SELECT** button to select Mode 4. The LCD will appear as shown while the drive ejects the tape (N is the slot the autoloader will attempt to move the tape to):



Use the **NEXT** or **PREVIOUS** button to scroll through the destination slot choices. Press **SELECT** when the slot you wish to place the tape in is displayed. When your autoloader has completed the command, it will return to LdR REAdY.

 **NOTE:** If the destination slot is full, a blinking RESELECT will appear on the LCD. The blinking RESELECT indicates that you attempted to select an invalid destination slot.

Mode 5 - DENSITY

Mode 5 is used to set the density format of the data cartridge tape. All previously unformatted DLTtape III, DLTtape IIIXT, and DLTtape IV data cartridges can be formatted to the densities shown in [Table 1](#).

Table 1. Maximum Capacity

Drive Model	Data Cartridge	Cartridge Density (native mode)	Cartridge Density (compressed mode)
DLT 8000	DLTtape III	2.6, 6.0, 10.0 GB	20.0 GB
	DLTtape IIIXT	15.0 GB	30.0 GB
	DLTtape IV	20.0, 35.0, 40.0 GB	40.0, 70.0, 80.0 GB

 **NOTES:**

- The density menu can only be used with a tape loaded in the drive.
- The density of previously recorded DLT data cartridges cannot be changed unless the tape is reformatted which will result in all data being lost.
- The default density of unformatted data cartridges is dependent upon the drive installed in your autoloader, and the type of tape being used.

To access Mode 5, press the **MODE** button until the LCD appears as shown:

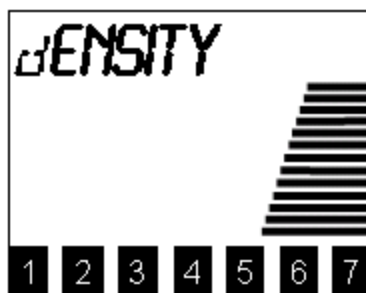

Press the **SELECT** button to select Mode 5. The LCD will appear as shown (XX is the lowest native density

selectable for this cartridge):

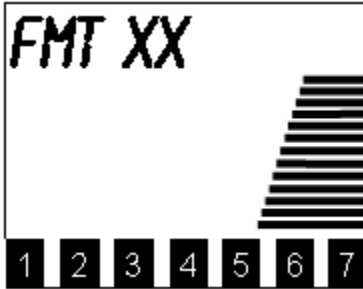

Press the **NEXT** or **PREVIOUS** button to scroll through the density choices. Press **SELECT** when the desired density setting is displayed. When your autoloader has completed the command, it will return to the LdR REAdY.

 NOTES:

- Attempting to select Mode 5 when the drive is empty will result in a NO TAPE error message appearing on the LCD. Press **MODE** to return the autoloader to LdR REAdY.
- If a NOT LOAdEd error message appears on the LCD when pressing **SELECT**, the current tape has not completed loading. Press **MODE** to clear the error and return the autoloader to LdR REAdY.
- If a CANNOT FMT error message appears on the LCD when pressing **SELECT**, the drive cannot reformat the cartridge (probably due to an incorrect cartridge type). Press **MODE** to clear the error and return the autoloader to LdR REAdY.

Mode 6 - SET SCSI ID

 NOTE: SCSI ID changes are not effective until power is cycled on the autoloader.

Use Mode 6 to set the SCSI ID of the autoloader robotics and/or the drive.

To access Mode 6, press the **MODE** button repeatedly until the LCD appears as shown:

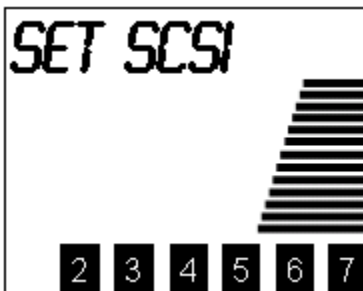

Press the **SELECT** button to select Mode 6. The LCD will appear as shown:

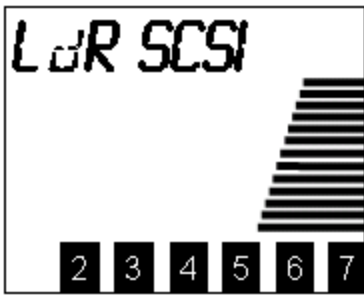

Press **SELECT** to choose the autoloader robotics. The LCD will appear as shown (X is the current ID of the robotics.):



Press **NEXT** or **PREVIOUS** button to scroll through the ID choices. Press **SELECT** when the desired ID is displayed. The LCD will appear as shown:

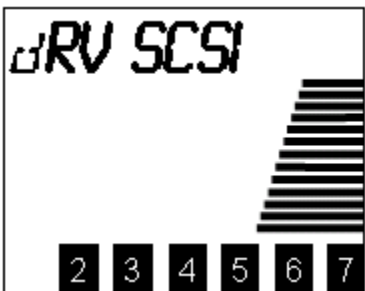

Press **SELECT** to choose the drive. The LCD will appear as shown (X is the current SCSI ID of the drive.):

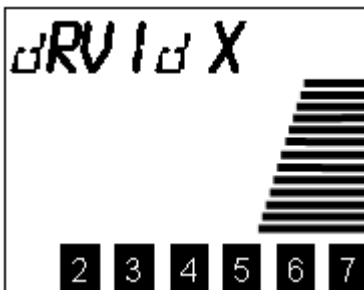

Press the **NEXT** or **PREVIOUS** button to scroll through the ID choices. Press **SELECT** when the desired ID is displayed. The LCD will appear as shown below. The **CYCLE PWR** message will blink for approximately 10 seconds and then the autoloader will return to LdR REAdY.

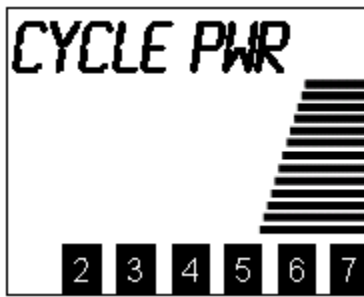

Press and hold the **POWER** button for approximately two seconds to power down the autoloader, then wait two or three seconds and press the **POWER** button again. The new SCSI ID will now be in effect.

Normal Maintenance

This section describes typical maintenance procedures for your drive and autoloader.

Cleaning the Drive Head

Keeping a drive clean is the single most important requirement for achieving and maintaining superior performance. Cleaning the head should always be performed as the first step if the **CT** field appears on the LCD. The tape head may be when the **CT** field appears on the Operator's Panel LCD.

Some application packages feature an auto clean cycle. If your application supports an auto clean function, it is strongly recommended that it is used.

 **NOTE:** Sun recommends that you use the built-in AUTOCLEAN feature if your application does not support an auto clean cycle. However, the tape capacity of the autoloader is reduced to six tapes whenever AUTOCLEAN is enabled.

Cleaning Tape

Use a DLT cleaning tape to clean the drive heads. A cleaning cartridge is shipped with your autoloader, see [Figure 2](#).

Figure 2. DLT Cleaning Tape

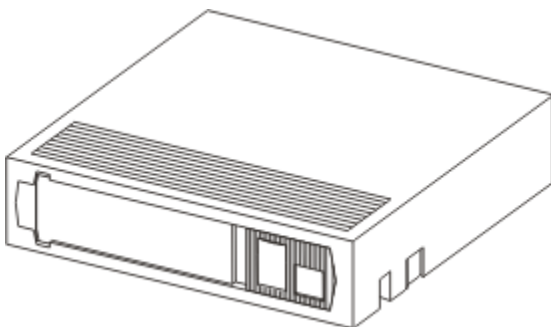

 **NOTE:** The cleaning cartridge is exhausted after it has performed 20 cleanings. The cleaning tape includes a label with 20 small boxes printed on it. Always place a check mark in a box each time the tape performs

a cleaning. Replace the cleaning cartridge when it has performed 20 cleanings (all boxes will be checked).

[Table 2](#) tells you when to use the cleaning tape.

Table 2. Cleaning Tape Usage

If . . .	It means . . .	You should . . .
1. The CT field appears on the Operator's Panel LCD	The drive head needs cleaning or the tape is bad	Use the cleaning tape to clean the drive head. When cleaning is complete, log the cleaning onto the label.
2. A data cartridge causes the CT field to appear on the Operator's Panel LCD	The data cartridge may be damaged	Back up the data from this cartridge onto another cartridge, it may be damaged. A damaged cartridge may cause unnecessary use of the cleaning cartridge.
3. The CT field re-appears after performing a cleaning and reloading the data cartridge.	Cleaning was not accomplished because the cleaning tape has exhausted all cleaning cycles. OR The data cartridge may be damaged	Replace the cleaning cartridge. Back up the data from this cartridge onto another cartridge, it may be damaged. A damaged cartridge may cause unnecessary use of the cleaning cartridge.

The following procedure is to be used only if your application does not support an auto clean cycle and you choose not to use the Autoclean feature (refer to [Troubleshooting and Diagnostics](#) for a detailed description of the Autoclean feature), or the CLEAN dRV function under the Diagnostics Menu (refer to [Troubleshooting and Diagnostics](#) for a detailed description of the CLEAN dRV function).



NOTES:

- To initiate the cleaning cycle manually you must be aware of the present state of the autoloader and the drive that you wish to clean. The drive and storage slot 2 must be empty.
- If a cartridge is present in the drive, you must first use the Mode 1B - EJECT dRV operation to remove the cartridge. If necessary, manually remove the data cartridge from slot 2. You can then proceed with these instructions.



CAUTION: Cleaning cartridges are considerably more abrasive to the drive's recording head than standard data cartridges. Usage should be kept within the recommended limits.

1. Open the front door of the autoloader.
2. Insert the cleaning cartridge into an empty storage slot.
3. Use Mode 1A - LOAd dRV to load the cleaning tape into the drive.

The cleaning cycle will be performed. When cleaning is completed, perform the following instructions:

1. Use Mode 1B - EJECT dRV to unload the cleaning tape from the drive and place it back in the storage slot.
2. Remove the cleaning cartridge and check a usage box on the label.

3. To resume normal operation, close the door and lock it.

Cleaning the Enclosure

The outside of the enclosure can be cleaned with a damp towel. If you use a liquid all-purpose cleaner, apply it to the towel. Do not directly spray the enclosure.

Troubleshooting and Diagnostics

This Chapter ...

- contains some general suggestions to aid you in solving problems—should you ever run into them
 - includes information on error codes and the built-in diagnostics
 - describes how to prepare the autoloader for moving or shipping
-

Installation Problems

Usually, problems encountered during the installation of your autoloader are caused by improper SCSI bus configuration, application software configuration errors, or by an operating system (OS) that has not been correctly configured. If the application software that you are attempting to use is not communicating with your library after installation, check the following:

- **SCSI IDs:** Make sure that the IDs you selected for the autoloader robotics and tape drive are not the same as the ID used by any other SCSI device on that bus, including the host SCSI adapter card.
 - **SCSI Cabling:** Verify that all SCSI cables are securely connected at both ends and that the bail locks are secured. Also, check the length and integrity of your SCSI cabling. The total length of all cables connected to a SCSI bus must not exceed 25 meters (82 feet) for HVD configurations. Try replacing suspected cables with known good cables.
 -  **NOTE:** The length of the autoloader internal SCSI cables is 1 foot. This length must be included in any calculations of cable length.
 - **Termination:** Check that all SCSI buses are properly terminated
 - **Compatibility:** Ensure that your autoloader and its tape drive are compatible with the SCSI adapter card and application software you plan to use.
 - **SCSI Adapter Card Installation:** Verify that you have installed your SCSI adapter card correctly. Refer to the documentation that came with your card for installation and troubleshooting instructions. Pay particular attention to any steps describing the settings of various jumpers and/or switches on the card. Check that the card is seated fully in your computer's I/O connector.
 - **Application Software Installation:** Refer to the documentation included with your software for instructions on how to verify installation.
-

Loader and Drive Operational Problems

Many problems with the operation of your autoloader and/or DLT drive occur when the drive is not cleaned on request or when you use incorrect data cartridges. If you have been successfully operating the application software and the autoloader in the past, but are now experiencing problems reading and writing data, check the following:

- If you are writing data, make sure that the cartridge is write enabled (move the write-protect switch to the enabled position).

- If the cartridge has been in use for a long time or if it has been used frequently, try using a new cartridge.
- Check the data cartridge you are using to confirm compatibility with your drive model.

Using the Diagnostic Menu

This section provides information on each of the diagnostic functions available through the Operator Panel keypad.

 **NOTE:** The autoloader will automatically exit the DIAG MENU and return to LdR REAdY if the keypad is idle for 30 seconds.

The Diagnostic Menu is accessed by pressing and holding first the **NEXT** button and then the **MODE** button concurrently for approximately five seconds. The LCD will appear as shown:



The following functions are available under the DIAG MENU:

dSP FW	When executed, this function displays the revision of the operating firmware used by autoloader microprocessors and the drive.
SIGN ON	Use this function to control how your autoloader appears to your host application.
CHG MOdE	Use this function to change the mode of operation from/to RANDOM or SEQUENTIAL.
CYCLE TEST	This function allows you to verify the functionality of the autoloader robotics. CYCLE TEST exercises the autoloader robotics by executing a sequence of pick and place operations, moving the cartridges between the slots and the drive.
CLEAN dRV	The CLEAN DRV function permits you to clean the drive head manually. Use this function if your application software does not support an auto cleaning cycle, and you do not want to dedicate slot 7 to the autoloader AUTOCLEAN feature.
AUTOCLEAN	AUTOCLEAN provides an automatic cleaning cycle. Use AUTOCLEAN only if your application software does not support an auto cleaning cycle. Slot 7 is dedicated to the cleaning cartridge whenever AUTOCLEAN is enabled, reducing the autoloader data capacity to 6 tapes.
LOAd FW	When executed, this function allows you to upgrade the autoloader firmware via the SCSI bus.
dSP COUNTS	The autoloader keeps track of how many times certain events have occurred. The dSP COUNTS function returns these numbers to the

	display.
UPG dRV FW	This function allows you to upgrade the drive firmware using a firmware upgrade (FUP) tape.

Display Firmware

1. After entering the DIAG MENU, press the **MODE** button to access the dSP FW function. The LCD will appear as shown:

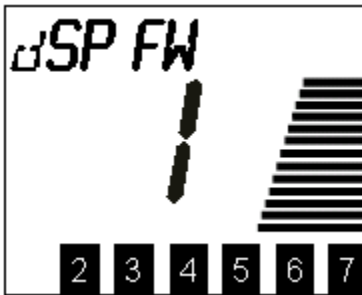

2. Press the **SELECT** button to access the dSP LdR FW sub-function. The LCD will appear as shown:



3. Press the **SELECT** button to display the firmware revision for the autoloader. The LCD will appear as shown (NNNN is the revision number of the firmware):



4. Press **NEXT** to access the dSP dRV FW sub-function. The LCD will appear as shown:



5. Press the **SELECT** button to display the firmware revision for the drive. The LCD will appear as shown (NNNN is the revision number of the firmware):



6. Press **NEXT** to access the dSP MTN FW sub-function. The LCD will appear as shown:

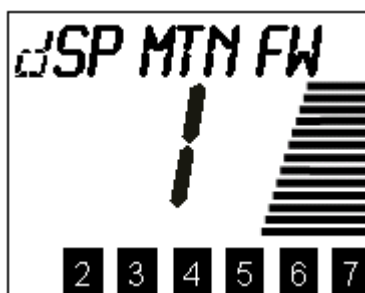

7. Press the **SELECT** button to display the firmware revision for the Motion firmware. The LCD will appear as shown (NN is the revision number of the firmware):



8. Press **NEXT** to access the dSP FP FW sub-function. The LCD will appear as shown:

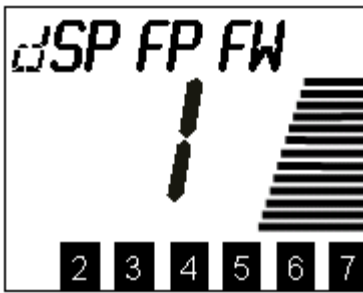

9. Press the **SELECT** button to display the firmware revision for the front panel firmware. The LCD will appear as shown (NNNN is the revision number of the firmware):



10. Press **NEXT** to access the dSP bT FW sub-function. The LCD will appear as shown:

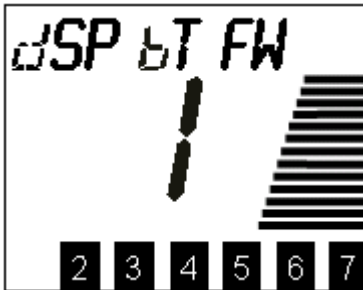

11. Press **SELECT** to display the firmware revision for the boot firmware. The LCD will appear as shown (NNNN is the revision number of the firmware):



12. Press **SELECT** to return the autoloader to LdR REAdY.

Sign On

1. After entering the DIAG MENU, press the **MODE** button until SIGN ON appears on the LCD:

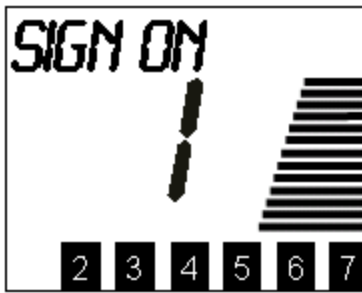

2. Press the **SELECT** button to display the current sign on string.

 **NOTE:** You should always have the sign on set to FASTSTOR.

Change Mode

Your autoloader is capable of operating in either Random-Access or Sequential-Access modes.

When in Random-Access mode, the autoloader allows software selection of any data cartridge in any order. You can logically divide cartridge usage to satisfy particular data storage needs. For example, you can assign one or more cartridges to specific data functions (such as certain directories or network servers), or you can assign specific cartridges to individual users or groups (such as Sales or Engineering).

When in Sequential-Access mode, all cartridges present are considered to be a single volume. The autoloader operating firmware predefines the selection of the cartridges. After initialization, the firmware will always load the first cartridge found (counting from 1 through 7) into the drive. After the application software has filled this cartridge the autoloader will automatically unload the drive, return the cartridge to its storage slot, and then load the next cartridge in order. Empty storage slots are ignored. The autoloader will continue this process until the volume is full. It is important to note that while in Sequential-Access mode, the autoloader robotics is not logically connected to the SCSI bus and does not respond to SCSI commands.

1. After entering the DIAG MENU, press the **MODE** button until CHG MOdE appears on the LCD:



2. Press the **SELECT** button to display the current mode.
3. Press the **NEXT** or **PREVIOUS** button to toggle the mode between SEQUENTIAL and RANDOM.
4. Press the **SELECT** button. CYCLE PWR will blink and appear on the LCD for approximately 10 seconds.
5. Press and hold the **POWER** button for two seconds to power down the autoloader.
6. Wait a few seconds, then press the **POWER** button again to power up the autoloader.

When in Sequential-Access mode, the autoloader replaces the LdR REAdY message with a SEQ REAdY message.

If you press **MODE** when the autoloader is in Sequential-Access mode, a STOP SEQ menu will appear on the LCD. Pressing **SELECT** while in this menu will cause a SEQ ENDING message to replace the LdR REAdY message and Sequential mode will finish after the currently loaded cartridge is unloaded. Pressing **MODE** after the cartridge is unloaded will cause autoloader to enter the normal menu structure.

When the SEQ ENDING message is displayed, pressing **MODE** before the current cartridge is unloaded will cause a RESUME SEQ menu to be displayed. Pressing **SELECT** while in this menu will cause the previous STOP SEQ request to be canceled and Sequential mode will continue with the current cartridge as if STOP SEQ had never been requested.

When the last cartridge in the volume has been filled, a SEQ dONE message will replace the SEQ REAdY message.

When the SEQ dONE message is displayed, pressing **MODE** will cause a START SEQ menu to be displayed. Pressing **SELECT** while in this menu will cause Sequential mode to restart. Pressing **MODE** while in this menu will cause autoloader to enter the normal menu structure.

Cycle Test

NOTES:

- Before executing CYCLE TEST, verify that the drive is empty. If necessary, use Mode 1B - EJECT DRIVE, to remove any cartridge from the drive.
- Before executing CYCLE TEST, verify that all seven cartridge slots have tapes installed. If required, install additional cartridges.
- If AUTOCLEAN is enabled and a cleaning tape is in slot 7, CYCLE TEST will not use slot 7 during the test.

1. After entering the DIAG MENU, press the **MODE** button until CYCLE TEST appears on the LCD:



2. Press **SELECT** to initiate the CYCLE TEST function. The following will appear on the LCD:

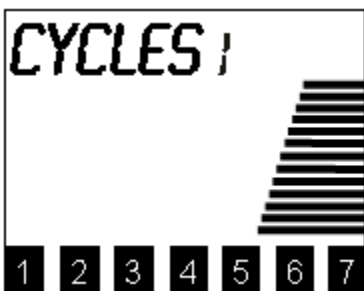

3. Press the **NEXT** button to cycle through the number of desired cycles.

4. Press **SELECT** when the desired number of cycle tests is displayed.

 NOTES:

- If you want the autoloader to execute CYCLE TEST continually, press **PREVIOUS** until CYCLE is displayed.
- Press **SELECT** to execute continuous CYCLE TEST.
- To terminate continuous CYCLE TEST, press and hold **MODE** for approximately 10 seconds.

During CYCLE TEST execution, the autoloader moves the cartridges from one slot to another, and places each cartridge into the drive.

When CYCLE TEST is completed, your autoloader will return to LdR REAdY.

Clean Drive

The following procedure is to be used only if your application does not support an autoclean cycle and you choose not to use the autoloader AUTOCLEAN feature.

1. After entering the DIAG MENU, press the **MODE** button until CLEAN dRIVE appears on the LCD:



2. Press the **SELECT** button to begin the drive head cleaning process. The LCD will display the following blinking message:

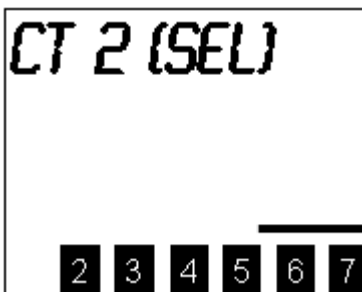

3. If necessary, place a cleaning tape in slot 2 then press **SELECT**. autoloader will move the cleaning tape to the drive and cleaning will begin. During cleaning the following message will be displayed on the LCD, and the activity bars will indicate the drive activity.



 NOTES:

- If you press **SELECT** before placing the cleaning cartridge in slot 2, the autoloader will continue display the above message.
 - If a data cartridge is in slot 2 and you press **SELECT**, the autoloader will treat it like a cleaning cartridge and move it to the drive.
 - If a cartridge is in the drive when you press **SELECT**, a dRIVE FULL error will be posted. Clear error by pressing the **MODE** button. Use the EJECT dRV mode to remove the cartridge from the drive, then start the cleaning process again.
4. When the cleaning process is complete, the drive will automatically eject the cartridge, and the autoloader will place it back in slot 2. The following blinking message will then be displayed on the LCD:



5. Remove the cleaning cartridge from slot 2, then press the **SELECT** button to return the autoloader to LdR REAdY.

Autoclean

The autoclean function is for use with application software that does not support automated cleaning of the drive head. Applications that support automated cleaning manage tape location and use, including that of the cleaning cartridge. Do not use the autoclean function if your application software supports automated cleaning cycles.

Enabling Autoclean

 NOTE: The default condition is Autoclean Off.

1. After entering the DIAG MENU, press the **MODE** button until AUTOCLEAN appears on the LCD:

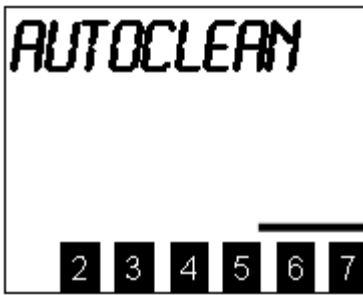

2. Press the **SELECT** button to access the autoclean function. The following message will be displayed on the LCD:

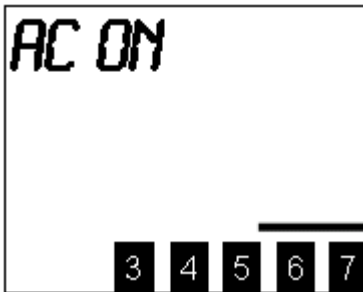

3. Press the **SELECT** button to enable the autoclean function. The following blinking message will be displayed on the LCD:

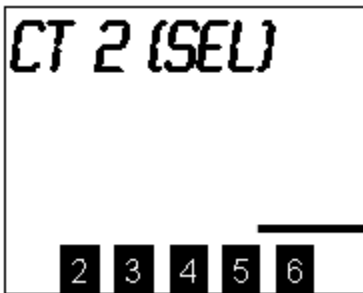

4. Place the cleaning cartridge in slot 2, then press **SELECT**. The autoloader will move the cartridge from slot 2 to slot 7.



NOTES:

- If, when you press **SELECT**, slot 7 is full, the autoloader will return a dEST FULL error message and autoclean will not be enabled. In this instance, use the UNLOAD SLOT mode to empty slot 7 first, then enable autoclean.
- If you wish to abort while enabling the autoclean function, before placing the cleaning cartridge in slot 2 and pressing **SELECT**, press the **MODE** button. The autoloader will return to LdR REAdY and autoclean will not be enabled.
- If you do not place the cleaning cartridge in slot 2 and press **SELECT** within 30 seconds, the function will timeout, the autoloader will return to the LdR REAdY, and autoclean will not be enabled.
- The Autoclean function is disabled until the autoloader places the cleaning cartridge in slot 7. If power is cycled prior to the autoloader placing the cartridge, autoclean will remain disabled.

- If a data cartridge is in slot 2 and you press **SELECT**, the autoloader will treat it like a cleaning cartridge and move it to slot 7.
- If a cartridge is in the drive when you place the cleaning cartridge in slot 2 and press **SELECT**, a dRIVE FULL error will be posted and autoclean will remain disabled. This is also true if the picker is full when you press **SELECT**. In either case, clear the error by pressing the **MODE** button. Then use the EJECT dRV mode to remove the cartridge from the drive, or the EJECT PCKR mode to remove the cartridge from the media picker, before again attempting to enable autoclean.

Using Autoclean

Autoclean will automatically perform a cleaning whenever the drive issues a Cleaning Requested status. After completion of the head cleaning, the autoloader will return the cleaning cartridge to slot 7.

NOTES:

- When autoclean is enabled, the application does not have access to slot 7, and autoloader appears as a 6 slot loader. This forces the application to remap the autoloader. Although slot 7 is unavailable to the application, the slot 7 indicator on the Operator Panel LCD functions normally (shows the presence of a cartridge when cleaning is not being performed).
- When autoclean is enabled you still have normal access to slot 7 from the front panel, allowing you to recover from the error if the cleaning cartridge gets stuck in the media picker.
- If the cleaning cartridge is ever in any slot other than 7, autoclean will not function.

If, during the cleaning, the drive issues a cleaning tape expired condition, the autoloader will display the following blinking message on the LCD:

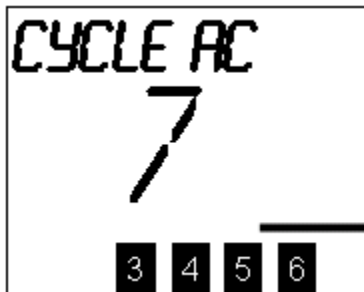

To clear the error condition, press the **MODE** button. Now use the front panel to replace the cleaning cartridge with a new one. This will allow autoclean to remain on. If desired, follow the instructions in the following section to first disable autoclean, then re-enable it using a new cleaning cartridge.

Disabling Autoclean

1. After entering the DIAG MENU, press the **MODE** button until AUTOCLEAN appears on the LCD:



2. Press the **SELECT** button to access the autoclean function. The following message will be displayed on the LCD:

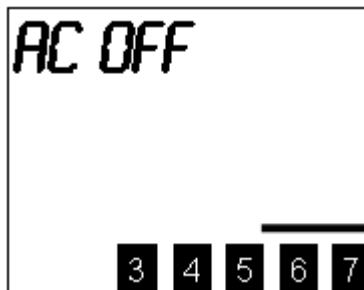

3. Press the **SELECT** button to disable the autoclean function. The autoloader will move the cleaning cartridge from slot 7 to slot 2. The following blinking message will be displayed on the LCD:



4. Remove the cleaning cartridge from slot 2, then press **SELECT**. The autoloader will return to LdR READy.

 **NOTES:**

- If a cartridge is present in slot 2, autoloader will post a dEST FULL error and autoclean will remain on.
- The autoclean function remains enabled until the autoloader places the cleaning cartridge in slot 2. If power is cycled after the media picker picks the cartridge, but prior to the autoloader placing the cartridge in slot 2, Autoclean will remain enabled. In this instance, when power is returned, use the EJECT PCKR Mode to place the cleaning cartridge in slot 7, then attempt to disable autoclean again.

Load Firmware

You can upgrade the autoloader firmware via the SCSI bus using the LOAd FW function. Contact Sun Support for more information on performing firmware upgrades.

Display Counts

1. After entering the DIAG MENU, press the **MODE** button until dSP COUNTS appears on the LCD:



2. Press the **SELECT** button to access the first event. The display will appear as shown:

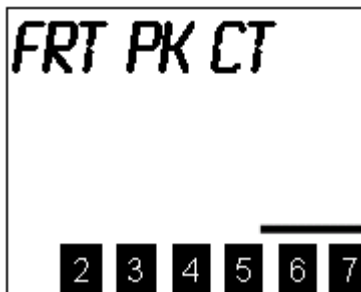

3. Press **SELECT** again to return the number of times that the autoloader has picked a cartridge from any of the front slots. The display will appear similar to the following:

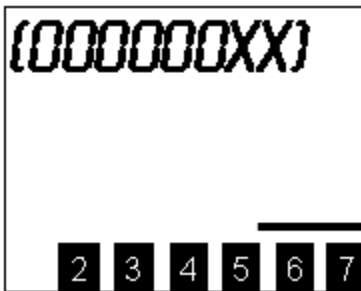

4. Press **NEXT** to access the next event.

The events that the autoloader keeps track of are listed below:

- Front Pick Cartridge
- Rear Pick Cartridge
- Drive Pick Cartridge
- Front Place Cartridge
- Rear Place Cartridge
- Drive Place Cartridge
- Front Pick Retries
- Rear Pick Retries
- Drive Pick Retries
- Front Place Retries
- Rear Place Retries
- Drive Place Retries

- Drive Door Retries

Pressing **SELECT** when the return value for dRV dR RE is displayed will return the autoloader to LdR REAdY. Also, pressing the **MODE** button at any time will return the autoloader to LdR REAdY.

Upgrade Drive Firmware

The following procedure is to be used only when you are upgrading the drive firmware using a firmware upgrade (FUP) tape. Contact Sun Support for more information on performing firmware upgrades.

1. After entering the DIAG MENU, press the **MODE** button until the following appears on the LCD:



2. Press **SELECT** to begin the drive firmware upgrade process. The following message will be blinking on the LCD:

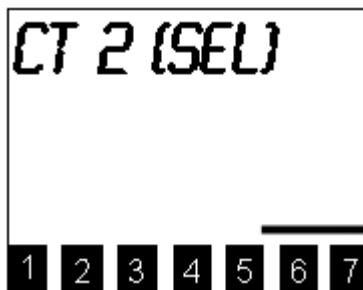

3. If not already installed, place a FUP tape in slot 2 then press **SELECT**. If you press **SELECT** before placing the FUP tape in slot 2, UPG dRV FW will appear momentarily on the LCD and then the blinking CT 2 (SEL) message will reappear.

The drive will be placed in a "prepare for firmware upgrade via tape" mode. The autoloader will move the FUP tape to the drive and the upgrade process will begin. UPdATING will appear on the LCD, the three front panel LEDs will alternate between POWER on, ACTIVITY off, ALARM on, POWER off, ACTIVITY on, ALARM off, and the activity bars will indicate the drive activity; also, the **POWER** button will be disabled during the upgrade.

When the update process is completed, the autoloader will auto-unload the tape and return it to slot 2. The following message will be blinking on the LCD:



4. Remove the FUP tape from slot 2, then press **SELECT** to return the autoloader to LdR REAdY.

If the dRIVE PGRM message and the error indicator **E** appear on the LCD after several minutes, perform the following:

1. Verify that the tape is a valid FUP tape and not a data or cleaning cartridge.
2. If you believe that the tape is OK, repeat the update process. If the autoloader displays the same error message, call Support for assistance.

Error Messages

If, during operation of your autoloader an error occurs, the autoloader will halt the current operation and an error message will be displayed on the LCD. In all cases, after removing the cause of the problem, cycle power on your autoloader and try the last operation again.

A description of each of the autoloader error messages is provided in the following table:

Error Name	Description	Error Name	Description
SERIAL RCV	Interprocessor communication error	PCKR EMPTY *	The media picker was empty
SRC EMPTY *	The source location is empty	SLOT FULL *	There was medium in slot
dEST FULL *	The destination location is full	NVM SELECT	NVRAM selection failure
CPU RX ERR	The motion CPU is not ready to receive	NVM WRITE	NVRAM write failure
CPU TX ERR	The motion CPU is not ready to transmit	dRIVE EJCT	Drive failed to eject medium
SLOT EMPTY	No slot beam was detected	dRIVE LOAd	Unable to load medium into drive
PWR SWITCH	The front power switch was pressed	dRIVE UNLd *	Drive not logically unloaded
HALT	The motion CPU has been halted by a low ACT line	dRIVE HNdL	Drive 'Operate Handle' timeout
CAM LIMIT	A cam limit has been reached without tripping a sensor	dRIVE BUSY	Drive busy, cannot unload tape
JAW SENSOR	A jaw sensor was tripped	dRIVE PGRM	Attempt to set drive parameters failed

INV MOV OP *	An invalid move operation occurred	dRIVE dOOR	Drive door stepper motor limit
REAR TAPE	A rear tape sensor was not tripped	dRIVE FULL *	The drive was full
FRONT TAPE	A front tape sensor was not tripped	CT FAILED	Cleaning tape failed to clean drive
REAR SLOT	A rear slot sensor was not tripped	dRIVE POST	Drive failed its POST
FRONT SLOT	A front slot sensor was not tripped	RObOT POST	Robotics failed its POST
PCKR FULL *	The media picker was full		

* These errors will not appear on the LCD if the error occurred during SCSI interaction.



NOTE: During the autoloader POST, if the CT FAILED, dRIVE bUSY, dRIVE dOOR, dRIVE EJCT, dRIVE HNdL, dRIVE LOAd, dRIVE PGRM, or dRIVE UNLd error occurs, dRIVE POST will appear on the Operators Panel LCD. All other errors occurring during autoloader POST will result in ROBOT POST being displayed.

Environmental Considerations

For best performance of your autoloader, and to minimize the chance of condensation, please observe the following guidelines:

- Install your autoloader on a level surface. Do not place the autoloader on a carpeted surface.
- If you expose cartridges to temperatures outside the operating limits, 10 - 40 °C (50 - 104 °F), stabilize them by leaving the cartridges in the operating temperature for a minimum of two hours before you use them.
- Avoid temperature problems by ensuring that the autoloader rear panel is not obstructed so that the drive has adequate ventilation.
- Position the autoloader where the temperature is relatively stable (i.e., away from open windows, fan heaters, and doors).
- Avoid leaving cartridges in severe temperature conditions, for example, in a car standing in bright sunlight.
- Avoid transferring data (reading from and writing to cartridges) when the temperature is changing by more than 10 °C (15 °F) per hour.

Moving or Shipping the Autoloader

If you ever need to move your autoloader to a new location or ship it back to Sun in exchange for a replacement unit, follow the instructions below. Moving or shipping the unit involves the following procedures:

- removing media
- removing cables/terminators

- de-racking (if applicable)
- removing the barcode reader (if applicable)

To remove media

1. Verify that the drive is empty.
2. If the drive contains a tape, unload it. Refer to the backup software documentation or use the front panel menu.
3. Remove all tapes from the autoloader.

To remove cables

1. Power off the autoloader by pressing the **POWER** button and holding it down for two seconds.



CAUTION: Do not power off the autoloader until the interface is inactive. Removing power from SCSI peripheral when the bus is active can result in data loss and/or indeterminate bus states your host system is connected to a LAN, be sure to check with your system administrator before powering off.

2. Disconnect the power cable from the back of the autoloader.
3. Disconnect the SCSI cable from the host and the back of the autoloader.
4. Remove the terminator from the back of the autoloader.



NOTE: If the autoloader is being moved internally, keep the power cable, SCSI cable, and terminator installed on the unit. If the autoloader is being replaced, keep the cables and terminator at your site or not ship them with the unit.

De-Racking

If your autoloader is rackmounted, you will need to de-rack the unit. De-racking the unit involves removing the unit from the rack and re-attaching the trim bezels, outer cover, and feet.

To de-rack your autoloader

1. Extend the rack's anti-tip foot.





WARNING: LOWER THE RACK'S LEVELER FEET AND EXTEND THE RACK'S ANTI-TIP DEVICE FAILURE TO EXTEND THE ANTI-TIP DEVICE COULD RESULT IN PERSONAL INJURY OR DAMAGE TO THE TAPE AUTOLOADER IF THE RACK TIPS OVER.

2. Loosen the thumbscrews that secure the autoloader into the rack.
3. Using two people or an appropriately rated mechanical lift, remove the autoloader from the rack tray by sliding it out and supporting it from the bottom.
4. When the unit has been removed from the rack assembly, the trim bezels and outer cover can be installed.

To re-install the trim bezels, outer cover, and feet

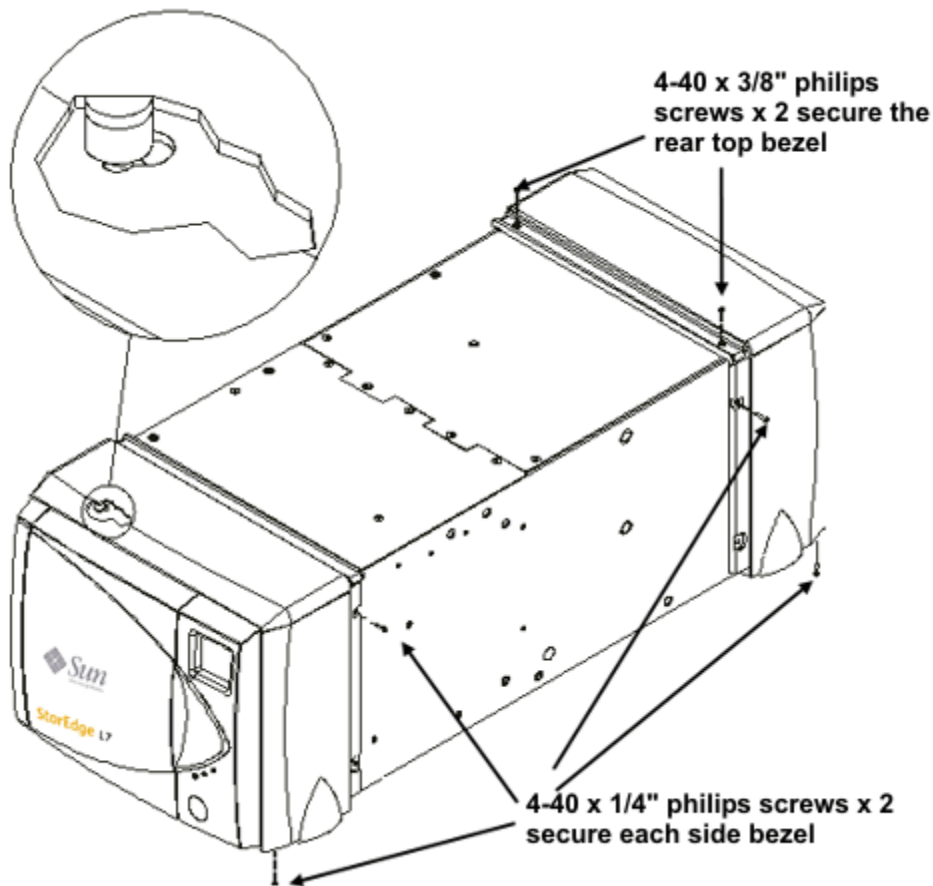
1. Insert the polymer button on the bezel into the appropriate keyhole in the chassis and move it in the correct direction to seat the button in the small end of the keyhole. Note that the left front side bezel has to be pulled forward to fit the button into the small end of its keyhole and the three other side bezels need to be pushed rearward to seat their buttons correctly (see the following graphic).
2. Use a # 1 phillips screwdriver to secure each side bezel to the chassis using the two 4-40 x 1/4" phillips screws that came with the autoloader.



3. Place the polymer buttons on each upper bezel into the appropriate keyholes in the top panels of the chassis.
4. Pull the front bezel forward and push the rear bezel backwards to seat the buttons in the small end of the keyholes.
5. Using a # 1 phillips screwdriver, secure the rear top bezel to the chassis using the two 4-40 x 3/8" phillips screws provided.
6. Slide the outer cover down over the exposed ends of the trim bezels until the three holes on each side align with the holes in the chassis and front and rear side bezels.
7. Using a # 1 phillips screwdriver, secure the middle of the outer cover to the chassis by tightening the two 4-40 x 1/4" phillips screws located in the middle holes. The following illustration shows the location of the screw on the right side of the cover. The location of the screw on the left side is similar.
 -  **NOTE:** If the two screws are missing from the middle location, install the nylock nut/washer assembly the inside of the cover using the two 4-40 x 3/8" phillips screws provided.
8. Using a # 1 phillips screwdriver, secure the front and back edge of the cover in place with the four 4-40 x 1/4" phillips screws provided. The following illustration shows the location of the screws on the right side of the cover. The location of the screws on the left side is similar.

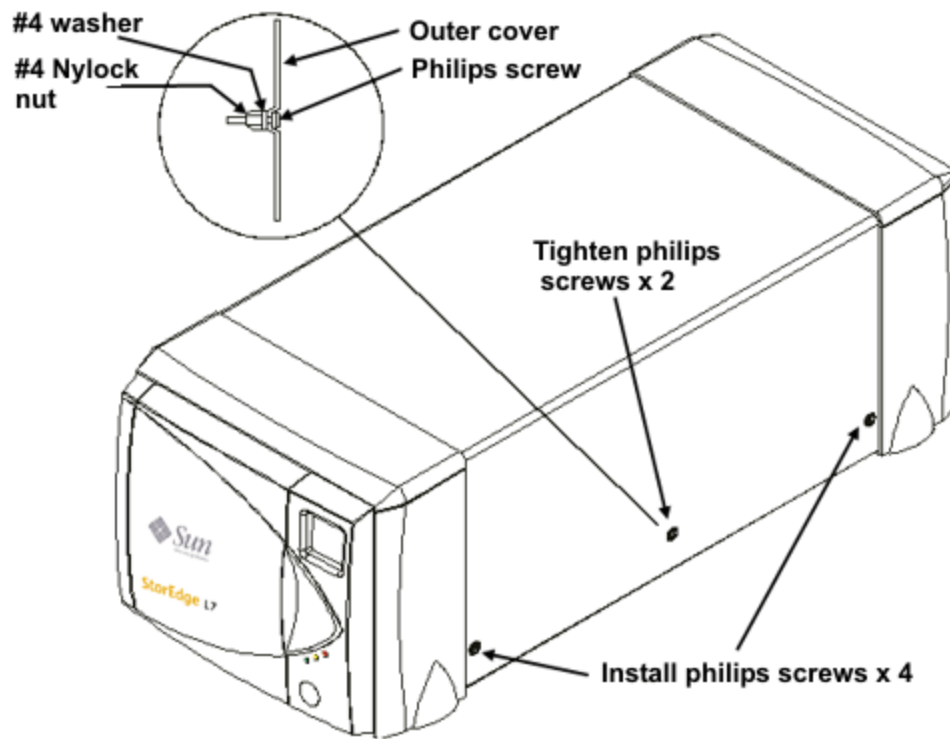

9. Re-install the four feet to the bottom of the autoloader using the four screws that came with the feet.

Removing a Barcode Reader

If your autoloader contains a barcode reader, remove it before shipping the unit.

To remove a barcode reader

1. Open the front door of your autoloader.
2. Remove the trim panel that is in front of the barcode reader.

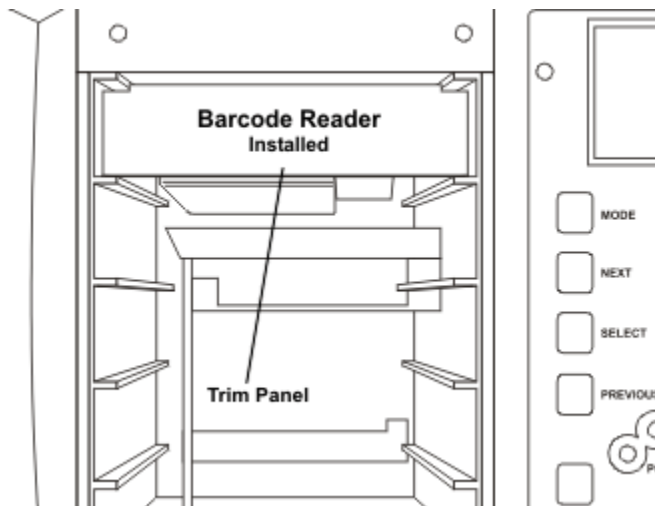

3. Loosen the thumbscrew on the barcode reader bracket until it frees the barcode reader from the inside top panel.

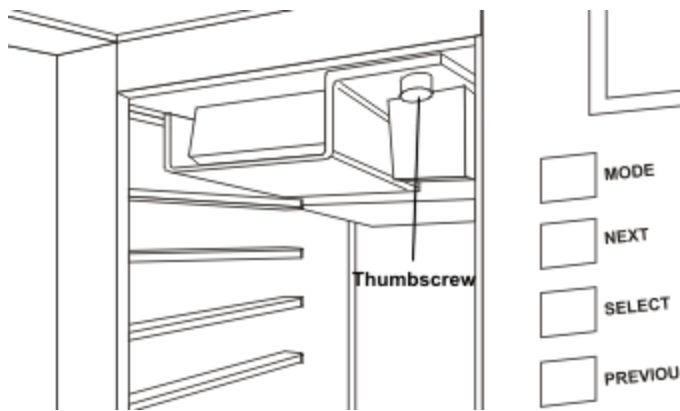

4. On the inside top panel, pull the interface connector on the barcode reader from the mating interface connector and remove the barcode reader.

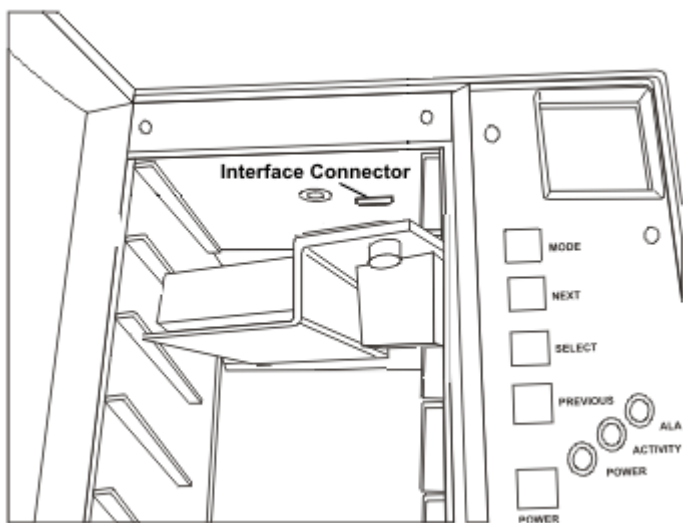

Your autoloader is now ready to ship. Place the autoloader in the original packaging box. If you no longer have the original packaging, contact your local service representative.

Contacting Support

Before contacting support, follow these steps—which will help you take full advantage of your call:

- Review all documentation carefully. Experience has demonstrated that most questions are answered in your documentation.
- Be prepared to explain whether the software or hardware has worked properly at anytime in the past. Have you changed anything recently?
- Pinpoint the exact location of your problem, if possible. Note the steps that led to the problem. Are you able to duplicate the same problem or is it a one-time occurrence?
- Note any error messages displayed on your PC screen or file server. Write down the exact error message.
- If at all possible, call while at your computer, with Sun's system installed and turned on.

- If running on a network, have all relevant information available (i.e., type, version #, network hardware, etc.).

Be prepared to provide:

- Your name and your Company's name
- Model number
- Serial number of autoloader (located inside the unit, under the bottom cartridge slot)
- Serial number of drive assembly (located on rear panel, above SCSI connectors)
- Software version numbers
 - device driver
 - archive/restore
- Hardware configuration, including firmware version, date and number
- Type of system, OS version, clock speed, type of HBA installed, network type, network version, and any special boards installed
- A brief description of the problem
- Where you purchased the Sun system

Having this information available when you call for customer assistance will enable Sun to resolve your problem in the most efficient manner possible.

Support Contact Information

To contact Sun Support, refer to [Consulting, Training and Support](http://www.sun.com/service/contacting/solution.html) (<http://www.sun.com/service/contacting/solution.html>) to find the Support Center nearest to you.

Specifications

This Chapter ...

- contains specification information on the StorEdge L7 and the DLT drive.

Drive

Type:	StorEdge L7 DLT 8000 - Quantum® model DLT8000
Data Capacity: (compressed mode)	Up to 80 GB per 1800 ft cartridge (DLT8000)
Data Transfer Rate: (compressed mode)	12.0 MB/sec. Sustained (720 MB/min., DLT8000)

Loader

Media type:	DLT ½-inch, metal-particle cartridges
Capacity:	Up to 560 GB
Cartridge Change:	10 seconds max
Indicators/Controls:	4 button keypad with LCD menu display, Power button, Power LED, Activity LED and Alarm LED to monitor and control system status, diagnostics and configuration
Interface:	StorEdge L7 DLT8000 - HVD, Fast/Wide SCSI, 68-pin HD

Reliability

Maintenance:	Drive head cleaning with DLT cleaning cartridge when indicated by drive, or automatic with Autoclean enabled.
MSBF:	Greater than 250,000 cartridge changes (net, drive and media) with scheduled maintenance.
MTBF:	More than 100,000 power-on hours
MTTR:	Within 30 minutes

Physical

Dimensions:	9.25" (w) x 23.25" (d) x 7.5" (h)
Weight:	26.5 lb
Shipping Weight:	37 lb

Power Consumption

Less than 85 Watts

Environment

Electrical:	100-120/220-240 Vac, 1.2-0.6 Amps, 50-60 Hz
Temperature:	10° C to 40° C (Operating)
Humidity:	5% to 80% RH, non-condensing (Operating) 90% maximum (Storage/Shipping)
Vibration:	0.3 g (5-500-5 Hz), Operating Tested per ISTA for storage/shipping
Shock:	3 g Operating Impact tested per ISTA for storage/shipping

Regulatory Notices

The regulatory notices for the StorEdge L7 are provided below.

FCC Notices (USA Only)

This equipment generates, uses, and can radiate radio frequency energy and, if not installed and used in accordance with the manufacturer's instruction manual, may cause interference with radio and television reception. This equipment has been tested and found to comply with the limits for a Class B digital device, pursuant to Part 15 of the FCC Rules. These limits are designed to provide reasonable protection against harmful interference in a residential installation. However, there is no guarantee that interference will not occur in a particular installation. If this equipment does cause harmful interference with radio or television reception, which can be determined by turning the equipment off and on, you are encouraged to try to correct the interference by one or more of the following measures:

- Reorient the receiving antenna.
- Relocate the equipment with respect to the receiver.
- Move the equipment away from the receiver.
- Plug the equipment into a different outlet so that the equipment and the receiver are on different branch circuits.

If necessary, consult a representative of Sun or an experienced radio/television technician for additional suggestions. You may find the following booklet helpful: *FCC Interference Handbook*, 1996, available from the U.S. Government Printing Office, Washington, DC 20402, Stock No. 004-000-00450-7.

This device complies with Part 15 of the FCC rules. Operation is subject to the following two conditions:

- This device may not cause harmful interference.
- This device must accept any interference received, including interference that may cause undesired operation.

A Notice About Shielded Cables: Use only shielded cables for connecting peripherals to this device to reduce the possibility of interference with radio and television reception. Using shielded cables ensures that you maintain the appropriate FCC radio frequency emissions compliance (for a Class A device) or FCC certification (for a Class B device) of this product.

The following information is provided on the device or devices covered in this document in compliance with FCC regulations:

<i>Product Name:</i>	StorEdge L7
<i>Model number:</i>	FS-DLT 8000
<i>Company name:</i>	Sun Microsystems, Inc. 4150 Network Circle Santa Clara, CA 95054

IC Notice (Canada Only)

Most tape libraries are classified by the Industry Canada (IC) Interference-Causing Equipment Standard #3 (ICES-003) as Class B digital devices. To determine which classification (Class A or B) applies to your tape library, examine all registration labels located on the bottom or the back panel of your library. A statement in the form of "IC Class A ICES-3" or "IC Class B ICES-3" will be located on one of these labels.

Note that Industry Canada regulations provide that changes or modifications not expressly approved by the tape library manufacturer could void your authority to operate this equipment.

This Class B (or Class A, if so indicated on the registration label) digital apparatus meets the requirements of the Canadian Interference-Causing Equipment Regulations.

Cet appareil numérique de la Classe B (ou Classe A, si ainsi indiqué sur l'étiquette d'enregistrement) respecte toutes les exigences du Règlement sur le Matériel Brouilleur du Canada.

EN 55022 Compliance (Czech Republic Only)

This device belongs to category B devices as described in EN 55022, unless it is specifically stated that it is a category A device on the specification label. The following applies to devices in category A of EN 55022 (radius of protection up to 30 meters). The user of the device is obliged to take all steps necessary to remove sources of interference to telecommunication or other devices.

Pokud není na typovém štítku počítače uvedeno, že spadá do třídy A podle EN 55022, spadá automaticky do třídy B podle EN 55022. Pro zařízení zařazená do třídy A (ochranné pásmo 30m) podle EN 55022 platí následující. Dojde-li k rušení telekomunikačních nebo jiných zařízení, je uživatel povinen provést taková opatření, aby rušení odstranil.

CE Notice

Marking by the symbol **CE** indicates compliance of this tape library to the EMC (Electromagnetic Compatibility) and the low voltage directive for the European Community. Such marking is indicative that this tape library meets or exceeds the following technical standards:

EN 55022 - "Limits and Methods of Measurement of Radio Interference Characteristics of Information Technology Equipment." This system is an EN 55022 Class B device.

EN 50081-1 - "Electromagnetic compatibility-Generic emission standard Part 1: Residential, commercial, and light industry."

EN 50082-1:1997 - "Electromagnetic compatibility-Generic immunity standard Part 1: Residential, commercial, and light industry."

EN 61000-3-2 - "Harmonic current emissions test." - Device Class A.

EN61000-3-3 - "Voltage fluctuations and flicker in low-voltage supply systems test."

EN 61000-4-2 - "Electrostatic discharge immunity test." - Severity level 3.

EN 61000-4-3 - "Radiated, radio-frequency, electromagnetic field immunity test." - Severity level 2.

EN 61000-4-4 - "Electrical fast transient/burst immunity test." - Severity level 2.

EN 61000-4-5 - "Surge immunity test." - Severity level 2.

EN 61000-4-6 - "Immunity to conducted disturbances, induced by radio-frequency fields." - Severity level 2.

EN 61000-4-8 - "Power frequency magnetic field immunity test." - Severity level 2.

EN 61000-4-11 - "Voltage dips, short interruptions and voltage variations immunity test." - Performance criteria B and C.

ENV 50204 - "Radiated electromagnetic field from digital radio telephones."

EN 60950:1992 + Amd.1:1993 + Amd.2:1993 with considerations to Amd.3:1995 - "Safety of Information Technology Equipment including Electrical Business Equipment."

VCCI Notices (Japan Only)

This is a Class B product based on the standard of the Voluntary Control Council for Interference for information technology equipment. If this equipment is used near a radio or television receiver in a domestic environment, it may cause radio interference. Install and use the equipment according to the instruction manual.

Note that VCCI regulations provide that changes or modifications not expressly approved by the tape library manufacturer could void your authority to operate this equipment.

Declaration of Conformity

The signed Declaration of Conformity is on file with Sun Microsystems, Inc: 4150 Network Circle, Santa Clara, CA 95054.